

# The versatile endurance runner

Wear resistance on (almost) all shafts,  
very low coefficient of friction

## iglide® J



### When to use it?

- For high speeds
- When highest wear resistance at low to medium pressures is required
- Low wear against different shafts
- When a low coefficient of friction in dry operation is requested
- For vibration dampening
- When good chemical resistance is required
- For best performance with soft shaft materials
- Low moisture absorption



### When not to use?

- When high pressures occur  
*iglide® G, iglide® W300*
- When short-term temperatures higher than +248°F occur  
*iglide® G, iglide® Z*
- When a cost-effective plain bearing for occasional movements is necessary  
*iglide® G*



Ø  
1.5 – 120mm  
1/8 - 2 in.

● Material available as:



Bar stock, round bar  
Page 761



Bar stock, plate  
Page 783



tribo-tape liner  
Page 791



Piston rings  
Page 685



Two hole flange bearings  
Page 709



Molded special parts  
Page 721



igubal® spherical balls  
Page 965



## The versatile endurance runner

### Wear resistance on (almost) all shafts, very low coefficient of friction

One main advantage of iglide® J plain bearings is the combination of a low coefficient of friction in dry operation and the low stickslip tendency. With a maximum recommended surface pressure of 5,076psi, iglide® J plain bearings are not suitable for extreme loads.

- Over 250 sizes available from stock
- High wear resistance
- Low coefficient of friction
- Vibration-dampening
- High chemical resistance
- Recommended for soft shafts
- Low moisture absorption

#### Typical application areas

- Automation
- Printing industry
- Beverage industry
- Aerospace engineering
- Cleanroom



#### Available from stock

Detailed information about delivery time online.



#### Online ordering

Including delivery times, prices, online tools

#### Descriptive technical specifications

Wear resistance at +73°F	-		+
Wear resistance at +194°F	-		+
Wear resistance at +302°F	-		+
Low coefficient of friction	-		+
Low moisture absorption	-		+
Wear resistance under water	-		+
High media resistance	-		+
Resistant to edge pressures	-		+
Suitable for shock and impact loads	-		+
Resistant to dirt	-		+



Online product finder  
[www.igus.com/iglidefinder](http://www.igus.com/iglidefinder)



Online service life calculation  
[www.igus.com/iglide-expert](http://www.igus.com/iglide-expert)

General properties			Testing method
Density	g/cm <sup>3</sup>	1.49	
Color		yellow	
Max. moisture absorption at +73°F and 50% r.h.	% weight	0.3	DIN 53495
Max. moisture absorption	% weight	1.3	
Coefficient of friction, dynamic, against steel	μ	0.06 – 0.18	
pv value, max. (dry)	psi · fpm	9,700	
Mechanical properties			
Flexural modulus	psi	348,091	DIN 53457
Flexural strength at +68°F	psi	10,588	DIN 53452
Compressive strength	psi	8,702	
Max. recommended surface pressure (+68°F)	psi	5,076	
Shore D hardness		74	DIN 53505
Physical and thermal properties			
Max. application temperature long-term	°F	+194	
Max. application temperature short-term	°F	+248	
Min. application temperature	°F	-58	
Thermal conductivity	W/m · K	0.25	ASTM C 177
Coefficient of thermal expansion (at +73°F)	K <sup>-1</sup> · 10 <sup>-5</sup>	10	DIN 53752
Electrical properties			
Specific contact resistance	Ωcm	> 10 <sup>13</sup>	DIN IEC 93
Surface resistance	Ω	> 10 <sup>12</sup>	DIN 53482



-58°F up to +194°F



5,076psi



**Table 01: Material properties**

One main advantage of iglide® J plain bearings is the combination of a low coefficient of friction in dry operation and the low stick-slip tendency.

### Moisture absorption

Under standard climatic conditions, the moisture absorption of iglide® J plain bearings is approximately 0.3% weight. The saturation limit in water is 1.3% weight. These values are so low that a moisture expansion need to be considered only in extreme cases.

### Vacuum

In vacuum, any present moisture is released as vapor. Use in vacuum is only possible with dehumidified iglide® J bearings.

### Radiation resistance

Plain bearings made from iglide® J are resistant up to a radiation intensity of  $3 \cdot 10^2$ Gy.

### Resistance to weathering

iglide® J plain bearings are resistant to weathering. The material properties are slightly affected. Discoloration occurs.

### Mechanical properties

With increasing temperatures, the compressive strength of iglide® J plain bearings decreases. Diagram 02 shows this inverse relationship. However, at the long-term maximum temperature of +194°F the permissible surface pressure is around 2,901psi. The maximum recommended surface pressure is a mechanical material parameter. No conclusions regarding the tribological properties can be drawn from this. With a maximum recommended surface pressure of 5,076psi, iglide® J plain bearings are not suitable for extreme loads. Diagram 03 shows the elastic deformation of iglide® J at radial loads.

► Surface pressure, [Page 50](#)

### Permissible surface speeds

The low coefficient of friction and the very low stick slip tendency of iglide® J plain bearings are particularly important at very low speeds. However, iglide® J can also be used for high speeds of over 197fpm. In both cases the static friction is very low and stick slip does not occur. The maximum values shown in table 03 can only be achieved at low pressures. At the given speeds, friction can cause a temperature increase to maximum permissible levels. In practice, though, this level is rarely reached due to varying application conditions.

► Surface speed, [Page 44](#)

## Temperature

iglide® J plain bearings can be used between -58°F and +194°F; the short-term maximum permissible temperature is +248°F. Wear increases significantly at temperatures above +176°F. For temperatures over +140°F an additional securing is required.

- Application temperatures, **Page 48**
- Additional securing, **Page 48**

## Friction and wear

Similar to wear resistance, the coefficient of friction  $\mu$  also changes with the surface speed and load (diagrams 04 and 05).

- Coefficient of friction and surfaces, **Page 47**
- Wear resistance, **Page 50**

Chemicals	Resistance
Alcohols	+
Diluted acids	0 up to -
Diluted alkalines	+
Fuels	+
Greases, oils without additives	+
Hydrocarbons	+
Strong acids	-
Strong alkalines	+ up to 0

All information given at room temperature [+68°F]

**Table 02: Chemical resistance**

- Chemical table, **Page 1762**

## Installation tolerances

iglide® J plain bearings are standard bearings for shafts with h tolerance (recommended minimum h9). The bearings are designed for press-fit into a housing machined to a H7 tolerance. After being assembled into a nominal size housing, in standard cases the inner diameter automatically adjusts to the E10 tolerances. For particular dimensions the tolerance differs depending on the wall thickness (please see product range table).

- Testing methods, **Page 57**
- Tolerance table, **Page 58**

For Inch Size Bearings		
Length Tolerance (b1)		Length of Chamfer (f) Based on d1
Length (inches)	Tolerance (h13) (inches)	
0.1181 to 0.2362	-0.0000 /-0.0071	f = .012 → d <sub>1</sub> .040" - .236"
0.2362 to 0.3937	-0.0000 /-0.0087	f = .019 → d <sub>1</sub> > .236" - .472"
0.3937 to 0.7086	-0.0000 /-0.0106	f = .031 → d <sub>1</sub> > .472" - 1.18"
0.7086 to 1.1811	-0.0000 /-0.0130	f = .047 → d <sub>1</sub> > 1.18"
1.1811 to 1.9685	-0.0000 /-0.0154	
1.9685 to 3.1496	-0.0000 /-0.0181	

## Shaft materials

The friction and wear are also dependent, to a large degree, on the shaft material. With increasing shaft surface finish, the coefficient of friction also increases. For iglide® J a ground surface with an average surface finish Ra = 0.1 – 0.3µm is recommended. Diagrams 06 and 07 show the test results of iglide® J plain bearings running against various shaft materials. When compared to most iglide® materials, iglide® J plain bearings have very low wear results at low loads compared with all shaft materials tested. Also, for increasing loads up to 725psi, the wear resistance of iglide® J is excellent. If the shaft material you plan on using is not shown in these test results, please contact us.

- Shaft materials, **Page 52**

		Rotating	Oscillating	linear
long-term	fpm	295	217	1575
short-term	fpm	591	413	1969

**Table 03: Maximum surface speeds**

	Dry	Greases	Oil	Water
Coefficient of friction $\mu$	0.06 – 0.18	0.09	0.04	0.04

**Table 04: Coefficient of friction against steel (Ra = 1µm, 50HRC)**

Ø d1 [mm]	Housing		Plain bearing		Shaft	
	H7 [mm]	E10 [mm]	E10 [mm]	E10 [mm]	h9 [mm]	h9 [mm]
0 – 3	+0.000	+0.010	+0.014	+0.054	-0.025	+0.000
> 3 – 6	+0.000	+0.012	+0.020	+0.068	-0.030	+0.000
> 6 – 10	+0.000	+0.015	+0.025	+0.083	-0.036	+0.000
> 10 – 18	+0.000	+0.018	+0.032	+0.102	-0.043	+0.000
> 18 – 30	+0.000	+0.021	+0.040	+0.124	-0.052	+0.000
> 30 – 50	+0.000	+0.025	+0.050	+0.150	-0.062	+0.000
> 50 – 80	+0.000	+0.030	+0.060	+0.180	-0.074	+0.000
> 80 – 120	+0.000	+0.035	+0.072	+0.212	-0.087	+0.000
> 120 – 180	+0.000	+0.040	+0.085	+0.245	-0.100	+0.000

**Table 05: Important metric tolerances for plain bearings according to ISO 3547-1 after press-fit**

For Metric Size Bearings		
Length Tolerance (b1)		Length of Chamfer (f) Based on d1
Length (mm)	Tolerance (h13) (mm)	
1 to 3	-0 /-140	f = 0.3 → d <sub>1</sub> 1 - 6 mm
> 3 to 6	-0 /-180	f = 0.5 → d <sub>1</sub> > 6 - 12 mm
> 6 to 10	-0 /-220	f = 0.8 → d <sub>1</sub> > 12 - 30 mm
>10 to 18	-0 /-270	f = 1.2 → d <sub>1</sub> > 30 mm
>18 to 30	-0 /-330	
>30 to 50	-0 /-390	
>50 to 80	-0 /-460	

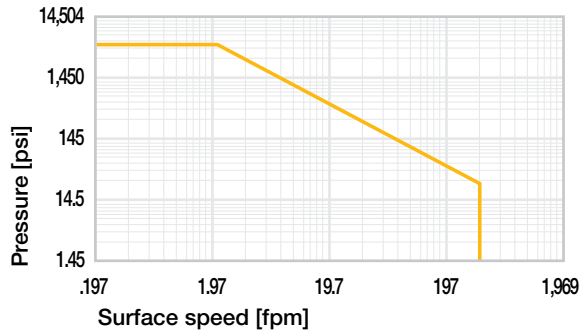

Diagram 01: Permissible pv values for iglide® J plain bearings with a wall thickness of 1mm, dry operation against a steel shaft, at +68°F, mounted in a steel housing

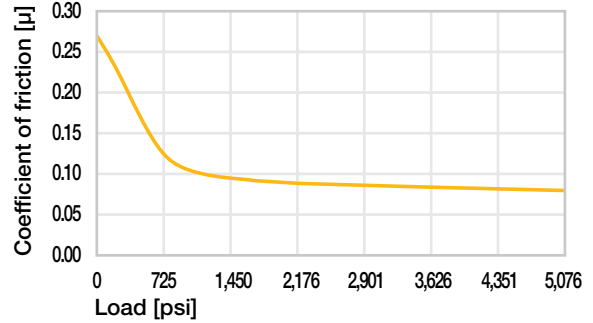

Diagram 05: Coefficient of friction as a function of the load,  $v = 1.97\text{fpm}$

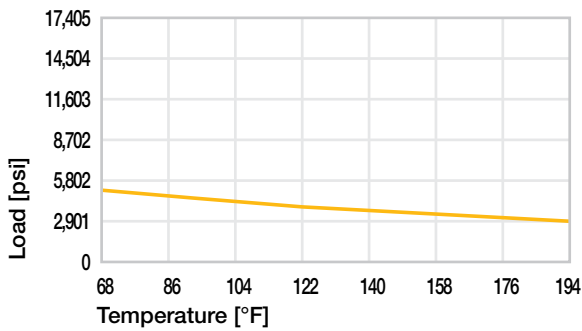

Diagram 02: Maximum recommended surface pressure as a function of temperature (5,076psi at +68°F)

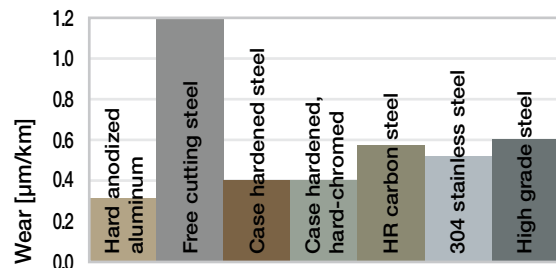

Diagram 06: Wear, rotating with different shaft materials, pressure,  $p = 145\text{psi}$ ,  $v = 59\text{fpm}$

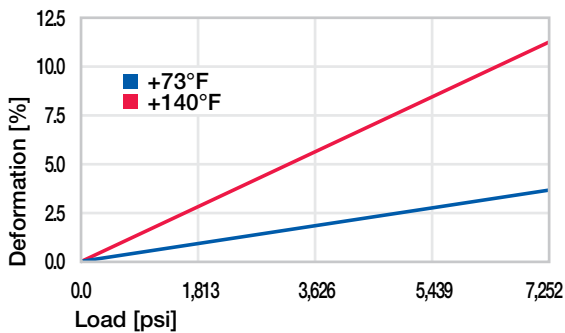

Diagram 03: Deformation under pressure and temperature

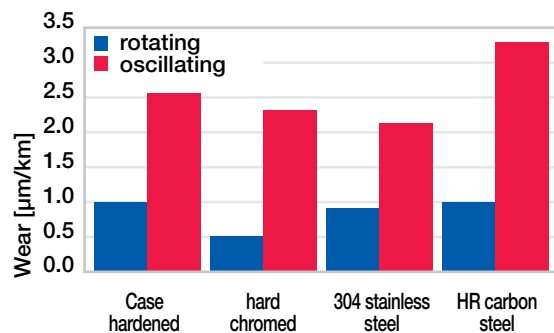

Diagram 07: Wear for rotating and oscillating applications with different shaft materials,  $p = 290\text{psi}$

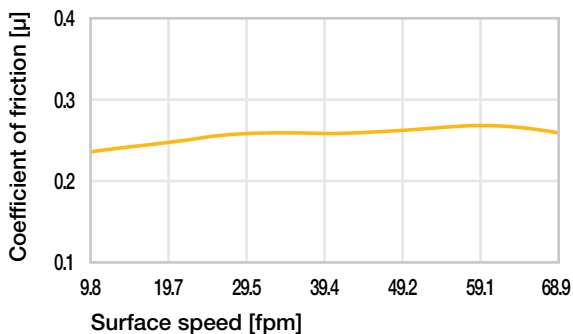
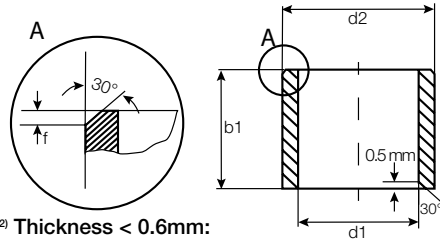

Diagram 04: Coefficient of friction as a function of the surface speed,  $p = 108\text{psi}$

# Bearing technology | Plain bearing | iglide® J

## Sleeve bearing (form S), inch



<sup>2)</sup> Thickness < 0.6mm:  
Chamfer = 20°

For tolerance values, page 196

### Chamfer in relation to d1

\*Based on steel housing bore

d1 [inch]	Ø .040-.236	Ø >.236-.472	Ø >.472-1.18	Ø > 1.18
f [inch]	.012	.019	.031	.047



Order key

Type	Dimensions
<b>J S I -02 04 -04</b>	
<b>iglide® material</b>	
<b>Form S (sleeve)</b>	
<b>Inch</b>	
<b>Inner Ø d1 (inch)</b>	
<b>Outer Ø d2 (inch)</b>	
<b>Length b1 (inch)</b>	

Part Number	d1	d2	b1	I.D. After Pressfit*		Housing Bore		Shaft Size	
				Min.	Max.	Min.	Max.	Min.	Max.
JSI-0203-03	1/8	3/16	3/16	.1251	.1269	.1873	.1878	.1236	.1243
JSI-0204-04	1/8	1/4	1/4	.1262	.1280	.2510	.2515	.1241	.1250
JSI-0204-06	1/8	1/4	3/8			.2510	.2515	.1241	.1250
JSI-0304-04	3/16	1/4	1/4	.1886	.1905	.2500	.2506	.1858	.1865
JSI-0304-06	3/16	1/4	3/8			.2500	.2506	.1858	.1865
JSI-0304-08	3/16	1/4	1/2			.2500	.2506	.1858	.1865
JSI-0305-05	3/16	5/16	5/16	.1887	.1905	.3135	.3140	.1866	.1875
JSI-0305-06	3/16	5/16	3/8			.3135	.3140	.1866	.1875
JSI-0305-08	3/16	5/16	1/2			.3135	.3140	.1866	.1875
JSI-0405-04	1/4	5/16	1/4	.2516	.2539	.3135	.3140	.2491	.2500
JSI-0405-06	1/4	5/16	3/8			.3135	.3140	.2491	.2500
JSI-0405-08	1/4	5/16	1/2			.3122	.3128	.2491	.2500
JSI-0406-04	1/4	3/8	1/4	.2516	.2539	.3760	.3765	.2491	.2500
JSI-0406-08	1/4	3/8	1/2			.3760	.3765	.2491	.2500
JSI-0406-12	1/4	3/8	3/4			.3760	.3765	.2491	.2500
JSI-0406-16	1/4	3/8	1			.3760	.3765	.2491	.2500
JSI-0506-04	5/16	3/8	1/4	.3125	.3148	.3747	.3753	.3106	.3115
JSI-0506-06	5/16	3/8	3/8			.3747	.3753	.3106	.3115
JSI-0506-08	5/16	3/8	1/2			.3747	.3753	.3106	.3115
JSI-0506-12	5/16	3/8	3/4			.3747	.3753	.3106	.3115
JSI-0506-16	5/16	3/8	1	.3141	.3164	.3747	.3753	.3106	.3115
JSI-0507-06	5/16	7/16	3/8			.4385	.4390	.3116	.3125
JSI-0507-07	5/16	7/16	7/16			.4385	.4390	.3116	.3125
JSI-0507-08	5/16	7/16	1/2			.4385	.4390	.3116	.3125
JSI-0507-10	5/16	7/16	5/8			.4385	.4390	.3116	.3125
JSI-0507-16	5/16	7/16	1			.4385	.4390	.3116	.3125
JSI-0607-08	3/8	7/16	1/2	.3766	.3789	.4385	.4390	.3741	.3750
JSI-0607-04	3/8	15/32	1/4	.3750	.3773	.4684	.4691	.3731	.3740
JSI-0607-06	3/8	15/32	3/8			.4684	.4691	.3731	.3740
JSI-06075-08	3/8	15/32	1/2			.4684	.4691	.3731	.3740
JSI-0607-10	3/8	15/32	5/8			.4684	.4691	.3731	.3740
JSI-0607-12	3/8	15/32	3/4			.4684	.4691	.3731	.3740
JSI-0608-03	3/8	1/2	3/16	.3764	.3787	.5000	.5006	.3736	.3750
JSI-0608-06	3/8	1/2	3/8			.5000	.5006	.3736	.3750
JSI-0608-08	3/8	1/2	1/2			.5000	.5006	.3736	.3750

Part Number	d1	d2	b1	I.D. After Pressfit*		Housing Bore		Shaft Size	
				Min.	Max.	Min.	Max.	Min.	Max.
JSI-0608-10	3/8	1/2	5/8	.3764	.3787	.5000	.5006	.3736	.3750
JSI-0708-08	7/16	17/32	1/2	.4379	.4406	.5309	.5316	.4366	.4375
JSI-0708-12	7/16	17/32	3/4			.5309	.5316	.4366	.4375
JSI-0709-06	7/16	9/16	3/8			.5625	.5632	.4366	.4375
JSI-0809-04	1/2	19/32	1/4	.5003	.5030.	.5934	.5941	.4980	.4990
JSI-0809-06	1/2	19/32	3/8			.5934	.5941	.4983	.5000
JSI-0809-08	1/2	19/32	1/2			.5934	.5941	.4983	.5000
JSI-0809-10	1/2	19/32	5/8			.5934	.5941	.4983	.5000
JSI-0809-12	1/2	19/32	3/4			.5934	.5941	.4983	.5000
JSI-0809-16	1/2	19/32	1			.5934	.5941	.4983	.5000
JSI-0810-04	1/2	5/8	1/4	.5020	.5047	.6250	.6260	.4990	.5000
JSI-0810-08	1/2	5/8	1/2			.6250	.6260	.4990	.5000
JSI-0810-10	1/2	5/8	5/8			.6250	.6260	.4990	.5000
JSI-0810-12	1/2	5/8	3/4			.6250	.6260	.4990	.5000
JSI-0910-08	9/16	21/32	1/2	.5627	.5655	.6559	.6566	.5605	.5615
JSI-0910-10	9/16	21/32	5/8			.6559	.6566	.5605	.5615
JSI-0910-12	9/16	21/32	3/4			.6559	.6566	.5605	.5615
JSI-0910-26	9/16	21/32	1 5/8			.6559	.6566	.5605	.5615
JSI-1011-08	5/8	23/32	1/2	.6253	.6280	.7184	.7192	.6230	.6240
JSI-1011-12	5/8	23/32	3/4			.7184	.7192	.6230	.6240
JSI-1011-14	5/8	23/32	7/8			.7184	.7192	.6230	.6240
JSI-1011-16	5/8	23/32	1			.7184	.7192	.6230	.6240
JSI-1011-20	5/8	23/32	1 1/4			.7184	.7192	.6230	.6240
JSI-1012-04	5/8	3/4	1/4	.6270	.6297	.7500	.7510	.6240	.6250
JSI-1012-06	5/8	3/4	3/8			.7500	.7510	.6240	.6250
JSI-1012-08	5/8	3/4	1/2			.7500	.7510	.6240	.6250
JSI-1012-12	5/8	3/4	3/4			.7500	.7510	.6240	.6250
JSI-1012-16	5/8	3/4	1			.7500	.7510	.6240	.6250
JSI-1214-08	3/4	7/8	1/2	.7505	.7541	.8747	.8755	.7479	.7491
JSI-1214-12	3/4	7/8	3/4			.8747	.8755	.7479	.7491
JSI-1214-16	3/4	7/8	1			.8747	.8755	.7479	.7491
JSI-1216-12	3/4	1	3/4	.7525	.7559	1.000	1.0010	.7490	.7500
JSI-1216-16	3/4	1	1			1.000	1.0010	.7490	.7500
JSI-1315-15	13/16	15/16	15/16	.8141	.8174	.9375	.9383	.8105	.8125
JSI-1315-18	13/16	15/16	1 1/8	.8130	.8163	.9375	.9383	.8105	.8125
JSI-1416-08	7/8	1	1/2	.8757	.8791	.9997	1.0005	.8729	.8741
JSI-1416-12	7/8	1	3/4			.9997	1.0005	.8729	.8741
JSI-1416-16	7/8	1	1			.9997	1.0005	.8729	.8741
JSI-1418-12	7/8	1 1/8	3/4	.8775	.8809	1.1250	1.1258	.8740	.8750
JSI-1418-24	7/8	1 1/8	1 1/2			1.1250	1.1258	.8740	.8750
JSI-1618-08	1	1 1/8	1/2	1.0007	1.0041	1.1247	1.1255	.9979	.9991
JSI-1618-12	1	1 1/8	3/4			1.1247	1.1255	.9979	.9991
JSI-1618-16	1	1 1/8	1			1.1247	1.1255	.9979	.9991
JSI-1618-24	1	1 1/8	1 1/2			1.1247	1.1255	.9979	.9991
JSI-1620-12	1	1 1/4	3/4	1.0025	1.0059	1.2500	1.2510	.9990	1.0000
JSI-1620-16	1	1 1/4	1			1.2500	1.2510	.9990	1.0000
JSI-1620-24	1	1 1/4	1 1/2			1.2500	1.2510	.9990	1.0000



# Bearing technology | Plain bearing | iglide® J

## Sleeve bearing (form S), inch

Part Number	d1	d2	b1	I.D. After Pressfit*		Housing Bore		Shaft Size	
				Min.	Max.	Min.	Max.	Min.	Max.
JSI-1820-12	1 1/8	1 9/32	3/4	1.1254	1.1288	1.2808	1.2818	1.1226	1.1238
JSI-1820-16	1 1/8	1 9/32	1	1.1254	1.1288	1.2808	1.2818	1.1226	1.1238
JSI-1820-20	1 1/8	1 9/32	1 1/4			1.2808	1.2818	1.1226	1.1238
JSI-1822-16	1 1/8	1 3/8	1	1.1276	1.1327	1.3750	1.3760	1.1240	1.1250
JSI-1822-28	1 1/8	1 3/8	1 3/4			1.3750	1.3760	1.1240	1.1250
JSI-2022-12	1 1/4	1 13/32	3/4	1.2508	1.2548	1.4058	1.4068	1.2472	1.2488
JSI-2022-14	1 1/4	1 13/32	7/8			1.4058	1.4068	1.2472	1.2488
JSI-2022-16	1 1/4	1 13/32	1			1.4058	1.4068	1.2472	1.2488
JSI-2022-20	1 1/4	1 13/32	1 1/4			1.4058	1.4068	1.2472	1.2488
JSI-2024-24	1 1/4	1 1/2	1 1/2	1.2532	1.2600	1.4995	1.5005	1.2490	1.2500
JSI-2426-16	1 1/2	1 21/32	1	1.5008	1.5048	1.6558	1.6568	1.4972	1.4988
JSI-2426-24	1 1/2	1 21/32	1 1/2			1.6558	1.6568	1.4972	1.4988
JSI-2426-32	1 1/2	1 5/8	2			1.6558	1.6568	1.4972	1.4988
JSI-2428-24	1 1/2	1 3/4	1 1/2	1.5032	1.5100	1.7495	1.7505	1.4990	1.5000
JSI-2629-16	1 5/8	1 25/32	1	1.6258	1.6297	1.7808	1.7818	1.6222	1.6238
JSI-2629-24	1 5/8	1 25/32	1 1/2			1.7808	1.7818	1.6222	1.6238
JSI-2831-16	1 3/4	1 15/16	1	1.7507	1.7547	1.9371	1.9381	1.7471	1.7487
JSI-2831-32	1 3/4	1 15/16	2			1.9371	1.9381	1.7471	1.7487
JSI-2832-20	1 3/4	2	1 1/4	1.7507	1.7547	2.0000	2.0010	1.7476	1.7500
JSI-2832-24	1 3/4	2	1 1/2			2.0000	2.0010	1.7476	1.7500
JSI-3033-16	1 7/8	2 1/16	1	1.8757	1.8796	2.0621	2.0633	1.8271	1.8737
JSI-3033-32	1 7/8	2 1/16	2			2.0621	2.0633	1.8271	1.8737
JSI-3235-16	2	2 3/16	1	2.0011	2.0057	2.1871	2.1883	1.9969	1.9981
JSI-3235-32	2	2 3/16	2			2.1871	2.1883	1.9969	1.9981
JSI-3236-32	2	2 1/4	2	2.0007	2.0047	2.2500	2.2510	1.9976	2.0000



## Flange bearing (form F), inch

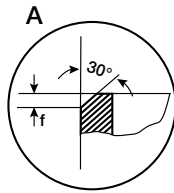

<sup>2)</sup> Thickness < 0.6mm:  
Chamfer = 20°

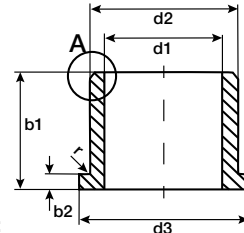

For tolerance values, page 196



### Order key

Type	Dimensions
J F I	-02 04-04
iglide® material	
Form F (flange)	
Inch	
Inner Ø d1 (inch)	
Outer Ø d2 (inch)	
Length b1 (inch)	

#### Chamfer in relation to d1

\*Based on steel housing bore

d1 [inch]	Ø .040-.236	Ø >.236-.472	Ø >.472-1.18	Ø > 1.18
f [inch]	.012	.019	.031	.047

Part Number	d1	d2	b1	d3	b2	I.D. After Pressfit*		Housing Bore		Shaft Size	
						Min.	Max.	Min.	Max.	Min.	Max.
JFI-0203-03	1/8	3/16	3/16	.312	.032	.1251	.1269	.1873	.1878	.1236	.1243
JFI-0204-02	1/8	1/4	1/8	.360	.047	.1262	.1280	.2510	.2515	.1241	.1250
JFI-0204-06	1/8	1/4	3/8	.360	.047			.2510	.2515	.1241	.1250
JFI-0304-02	3/16	1/4	1/8	.375	.032	.1887	.1905	.2497	.2503	.1858	.1865
JFI-0304-04	3/16	1/4	1/4	.375	.032	.1873	.1892	.2497	.2503	.1858	.1865
JFI-0304-06	3/16	1/4	3/8	.375	.032			.2497	.2503	.1858	.1865
JFI-0304-08	3/16	1/4	1/2	.375	.032			.2497	.2503	.1858	.1865
JFI-0305-06	3/16	5/16	3/8	.370	.047	.1887	.1905	.3135	.3140	.1866	.1875
JFI-0305-08	3/16	5/16	1/2	.370	.047			.3135	.3140	.1866	.1875
JFI-0405-04	1/4	5/16	1/4	.430	.032	.2516	.2539	.3122	.3128	.2481	.2490
JFI-0405-06	1/4	5/16	3/8	.430	.032			.3122	.3128	.2481	.2490
JFI-0405-08	1/4	5/16	1/2	.500	.032			.3122	.3128	.2481	.2490
JFI-0405-12	1/4	5/16	3/4	.430	.032			.3122	.3128	.2481	.2490
JFI-0406-03	1/4	3/8	3/16	.560	.047	.2516	.2539	.3760	.3765	.2491	.2500
JFI-0406-04	1/4	3/8	1/4	.560	.047			.3760	.3765	.2491	.2500
JFI-0406-08	1/4	3/8	1/2	.560	.047			.3760	.3765	.2491	.2500
JFI-0506-04	5/16	3/8	1/4	.500	.032	.3125	.3148	.3747	.3753	.3106	.3115
JFI-0506-06	5/16	3/8	3/8	.500	.032			.3747	.3753	.3106	.3115
JFI-0506-08	5/16	3/8	1/2	.500	.032			.3747	.3753	.3106	.3115
JFI-0507-08	5/16	7/16	1/2	.560	.062	.3141	.3164	.4385	.4390	.3116	.3125
JFI-0607-04	3/8	15/32	1/4	.687	.046	.3750	.3773	.4684	.4691	.3731	.3740
JFI-0607-06	3/8	15/32	3/8	.687	.046			.4684	.4691	.3731	.3740
JFI-0607-08	3/8	15/32	1/2	.687	.046			.4684	.4691	.3731	.3740
JFI-0607-12	3/8	15/32	3/4	.687	.046			.4684	.4691	.3731	.3740
JFI-0608-03	3/8	1/2	3/16	.625	.062	.3766	.3789	.5010	.5015	.3741	.3750
JFI-0608-04	3/8	1/2	1/4	.625	.062			.5010	.5015	.3741	.3750
JFI-0608-06	3/8	1/2	3/8	.625	.062			.5010	.5015	.3741	.3750
JFI-0608-08	3/8	1/2	1/2	.625	.062			.5010	.5015	.3741	.3750
JFI-0708-08	7/16	17/32	1/2	.750	.046	.4379	.4406	.5309	.5316	.4366	.4375
JFI-0708-12	7/16	17/32	3/4	.750	.046			.5309	.5316	.4366	.4375
JFI-0809-04	1/2	19/32	1/4	.875	.046	.5003	.5030	.5934	.5941	.4980	.4990
JFI-0809-06	1/2	19/32	3/8	.875	.046			.5934	.5941	.4980	.4990
JFI-0809-08	1/2	19/32	1/2	.875	.046			.5934	.5941	.4980	.4990
JFI-0809-12	1/2	19/32	3/4	.875	.046			.5934	.5941	.4980	.4990
JFI-0809-16	1/2	19/32	1	.875	.046			.5934	.5941	.4980	.4990

# Bearing technology | Plain bearing | iglide® J

## Flange bearing (form F), inch

Part Number	d1	d2	b1	d3	b2	I.D. After Pressfit*		Housing Bore		Shaft Size	
						Min.	Max.	Min.	Max.	Min.	Max.
					-.0055						
JFI-0810-04	1/2	5/8	1/4	.875	.062	.5020	.5047	.6250	.6260	.4990	.5000
JFI-0810-08	1/2	5/8	1/2	.875	.062			.6250	.6260	.4990	.5000
JFI-0810-10	1/2	5/8	5/8	.875	.062			.6250	.6260	.4990	.5000
JFI-0810-12	1/2	5/8	3/4	.875	.062			.6250	.6260	.4990	.5000
JFI-0810-16	1/2	5/8	1	.875	.062			.6250	.6260	.4990	.5000
JFI-1011-06	5/8	23/32	3/8	.937	.046	.6253	.6280	.7184	.7192	.6233	.6250
JFI-1011-08	5/8	23/32	1/2	.937	.046			.7184	.7192	.6233	.6250
JFI-1011-12	5/8	23/32	3/4	.937	.046			.7184	.7192	.6233	.6250
JFI-1011-16	5/8	23/32	1	.937	.046			.7184	.7192	.6233	.6250
JFI-1011-24	5/8	28/32	1 1/2	1.000	.046	.6268	.6295	.7184	.7192	.6233	.6250
JFI-1012-06	5/8	3/4	3/8	1.000	.062	.6270	.6297	.7500	.7510	.6240	.6250
JFI-1012-08	5/8	3/4	1/2	1.000	.062			.7500	.7510	.6240	.6250
JFI-1012-12	5/8	3/4	3/4	1.000	.062			.7500	.7510	.6240	.6250
JFI-1012-16	5/8	3/4	1	1.000	.062			.7500	.7510	.6240	.6250
JFI-1214-08	3/4	7/8	1/2	1.125	.062	.7505	.7541	.8747	.8755	.7479	.7491
JFI-1214-09	3/4	7/8	9/16	1.125	.062			.8747	.8755	.7479	.7491
JFI-1214-10	3/4	7/8	5/8	1.125	.062			.8747	.8755	.7479	.7491
JFI-1214-12	3/4	7/8	3/4	1.125	.062			.8747	.8755	.7479	.7491
JFI-1214-16	3/4	7/8	1	1.125	.062			.8747	.8755	.7479	.7491
JFI-1214-24	3/4	7/8	1 1/2	1.125	.062			.8747	.8755	.7479	.7491
JFI-1216-12	3/4	1	3/4	1.250	.156	.7525	.7559	1.0000	1.0010	.7490	.7500
JFI-1216-16	3/4	1	1	1.250	.156			1.0000	1.0010	.7490	.7500
JFI-1416-08	7/8	1	1/2	1.250	.062	.8757	.8791	.9997	1.0005	.8729	.8741
JFI-1416-12	7/8	1	3/4	1.250	.062			.9997	1.0005	.8729	.8741
JFI-141618-11	7/8	1	11/16	1.125	.062	.8774	.8807	.9997	1.0005	.8740	.8750
JFI-1416-16	7/8	1	1	1.250	.062	.8757	.8791	.9997	1.0005	.8729	.8741
JFI-1418-24	7/8	1 1/8	1 1/2	1.375	.156	.8775	.8809	1.1250	1.1260	.8740	.8750
JFI-1618-08	1	1 1/8	1/2	1.375	.062	1.0007	1.0041	1.1247	1.1255	.9979	.9991
JFI-1618-12	1	1 1/8	3/4	1.375	.062			1.1247	1.1255	.9979	.9991
JFI-1618-16	1	1 1/8	1	1.375	.062			1.1247	1.1255	.9979	.9991
JFI-1620-12	1	1 1/4	3/4	1.500	.188	1.0025	1.0059	1.2500	1.2510	.9990	1.0000
JFI-1620-16	1	1 1/4	1	1.500	.188			1.2500	1.2510	.9990	1.0000
JFI-1620-24	1	1 1/4	1 1/2	1.500	.188			1.2500	1.2510	.9990	1.0000
JFI-1820-08	1 1/8	1 9/32	1/2	1.562	.078	1.1254	1.1288	1.2808	1.2818	1.1226	1.1238
JFI-2022-16	1 1/4	1 13/32	1	1.687	.078	1.2508	1.2548	1.4058	1.4068	1.2472	1.2488
JFI-2022-20	1 1/4	1 13/32	1 1/4	1.687	.078			1.4058	1.4068	1.2472	1.2488
JFI-2024-16	1 1/4	1 1/2	1	1.750	.200	1.2531	1.2600	1.4995	1.5005	1.2490	1.2500
JFI-2024-24	1 1/4	1 1/2	1 1/2	1.750	.200			1.4995	1.5005	1.2490	1.2500
JFI-2426-16	1 1/2	1 21/32	1	2.000	.078	1.5008	1.5048	1.6558	1.6568	1.4972	1.4988
JFI-2426-24	1 1/2	1 21/32	1 1/2	2.000	.078			1.6558	1.6568	1.4972	1.4988
JFI-2428-16	1 1/2	1 3/4	1	2.000	.125	1.5032	1.5100	1.7495	1.7505	1.4990	1.5000
JFI-2428-24	1 1/2	1 3/4	1 1/2	2.000	.125			1.7495	1.7505	1.4990	1.5000
JFI-2630-16	1 5/8	1 7/8	1	2.125	.125	1.6282	1.6350	1.8745	1.8755	1.6240	1.6250
JFI-2831-32	1 3/4	1 15/16	2	2.375	.093	1.7507	1.7547	1.9371	1.9381	1.7471	1.7487
JFI-3235-32	2	2 3/16	2	2.625	.093	2.0011	2.0057	2.1871	2.1883	1.9969	1.9981
JFI-3236-16	2	2 1/4	1	2.500	.125	2.0032	2.0100	2.2495	2.2505	1.9990	2.0000

## Sleeve bearing (form S), metric

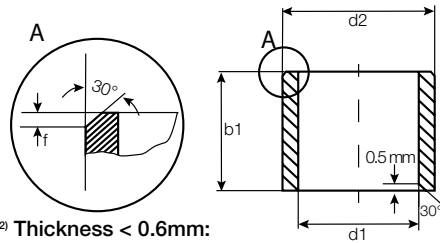

<sup>2)</sup> Thickness < 0.6mm:  
Chamfer = 20°  
For tolerance values, page 196



### Order key

Type	Dimensions
<b>J S M -01 04-02</b>	
iglide® material	Form S (sleeve)
Metric	Inner Ø d1 (mm)
	Outer Ø d2 (mm)
	Length b1 (mm)

**i** Dimensions according to ISO 3547-1 and special dimensions

#### Chamfer in relation to d1

d1 [mm]	Ø 1-6	Ø >6-12	Ø >12-30	Ø > 30
f [mm]	0.3	0.5	0.8	1.2

\*Based on steel housing bore

Part Number	d1	d2	b1	I.D. After Pressfit*		Housing Bore		Shaft Size	
				h13	Min.	Max.	Min.	Max.	Min.
JSM-0104-02	1.5	4.0	2.0	1.514	1.554	4.000	4.012	1.475	1.500
JSM-0203-07	2.0	3.5	7.0	2.014	2.054	3.500	3.512	1.975	2.000
JSM-0205-02	2.0	5.0	2.5	2.020	2.080	5.000	5.012	1.975	2.000
JSM-0206-02	2.5	6.0	2.5	2.520	2.580	6.000	6.012	2.475	2.500
JSM-0304-05	3.0	4.5	5.0	3.014	3.054	4.500	4.512	2.975	3.000
JSM-0304-09	3.0	4.5	9.0			4.500	4.512	2.975	3.000
JSM-0305-03	3.0	5.0	3.0	3.020	3.080	5.000	5.012	2.975	3.000
JSM-0305-04	3.0	5.0	4.0	3.020	3.080	5.000	5.012	2.975	3.000
JSM-0307-14	3.0	7.0	14.0			7.000	7.015	2.975	3.000
JSM-0308-04	3.0	8.0	4.0			8.000	8.015	2.975	3.000
JSM-0308-05	3.0	8.0	5.0			8.000	8.015	2.975	3.000
JSM-0405-04	4.0	5.5	4.0			4.020	4.068	5.500	5.512
JSM-0405-06	4.0	5.5	6.0	5.500	5.512			3.970	4.000
JSM-0405-08	4.0	5.5	8.0	5.500	5.512			3.970	4.000
JSM-0507-046	5.0	7.0	4.6	5.020	5.068	7.000	7.015	4.970	5.000
JSM-0507-05	5.0	7.0	5.0			7.000	7.015	4.970	5.000
JSM-0507-10	5.0	7.0	10.0			7.000	7.015	4.970	5.000
JSM-0507-14	5.0	7.0	14.0			7.000	7.015	4.970	5.000
JSM-0507-15	5.0	7.0	15.0	5.020	5.080	7.000	7.015	4.970	5.000
JSM-0508-05	5.0	8.0	5.0	5.030	5.105	8.000	8.015	4.970	5.000
JSM-0607-03	6.0	7.0	3.0	6.010	6.058	7.000	7.015	5.970	6.000
JSM-0607-05	6.0	7.0	5.0			7.000	7.015	5.970	6.000
JSM-0607-08	6.0	7.0	8.0			7.000	7.015	5.970	6.000
JSM-0607-12.5	6.0	7.0	12.5			7.000	7.015	5.970	6.000
JSM-0607-14	6.0	7.0	14.0			7.000	7.015	5.970	6.000
JSM-0608-043	6.0	8.0	4.3	6.020	6.068	8.000	8.015	5.970	6.000
JSM-0608-06	6.0	8.0	6.0			8.000	8.015	5.970	6.000
JSM-0608-08	6.0	8.0	8.0			8.000	8.015	5.970	6.000
JSM-0608-10	6.0	8.0	10.0			8.000	8.015	5.970	6.000
JSM-0609-06	6.0	9.0	6.0	6.030	6.105	9.000	9.015	5.970	6.000
JSM-0610-10	6.0	10.0	10.0			10.000	10.015	5.970	6.000
JSM-0709-05	7.0	9.0	5.0	7.025	7.083	9.000	9.015	6.964	7.000
JSM-0709-07	7.0	9.0	7.0			9.000	9.015	6.964	7.000
JSM-0709-09	7.0	9.0	9.0			9.000	9.015	6.964	7.000
JSM-0709-125	7.0	9.0	12.5			9.000	9.015	6.964	7.000

# Bearing technology | Plain bearing | iglide® J

## Sleeve bearing (form S), metric

Part Number	d1	d2	b1	I.D. After Pressfit*		Housing Bore		Shaft Size	
				Min.	Max.	Min.	Max.	Min.	Max.
JSM-0810-03	8.0	10.0	3.0	8.025	8.083	10.000	10.015	7.964	8.000
JSM-0810-04	8.0	10.0	4.0			10.000	10.015	7.964	8.000
JSM-0810-06	8.0	10.0	6.0			10.000	10.015	7.964	8.000
JSM-0810-08	8.0	10.0	8.0			10.000	10.015	7.964	8.000
JSM-0810-10	8.0	10.0	10.0			10.000	10.015	7.964	8.000
JSM-0810-12	8.0	10.0	12.0			10.000	10.015	7.964	8.000
JSM-0810-16	8.0	10.0	16.0			10.000	10.015	7.964	8.000
JSM-0812-10	8.0	12.0	10.0	8.040	8.130	12.000	12.018	7.964	8.000
JSM-0812-12	8.0	12.0	12.0			12.000	12.018	7.964	8.000
JSM-0911-06	9.0	11.0	6.0	9.025	9.083	11.000	11.018	8.964	9.000
JSM-0911-10	9.0	11.0	10.0			11.000	11.018	8.964	9.000
JSM-1012-05	10.0	12.0	5.0	10.025	10.083	12.000	12.018	9.964	10.000
JSM-1012-06	10.0	12.0	6.0			12.000	12.018	9.964	10.000
JSM-1012-08	10.0	12.0	8.0			12.000	12.018	9.964	10.000
JSM-1012-10	10.0	12.0	10.0			12.000	12.018	9.964	10.000
JSM-1012-11	10.0	12.0	11.0			12.000	12.018	9.964	10.000
JSM-1012-12	10.0	12.0	12.0			12.000	12.018	9.964	10.000
JSM-1012-15	10.0	12.0	15.0			12.000	12.018	9.964	10.000
JSM-1012-20	10.0	12.0	20.0			12.000	12.018	9.964	10.000
JSM-1014-10	10.0	14.0	10.0	10.040	10.130	14.000	14.018	9.964	10.000
JSM-1014-16	10.0	14.0	16.0			14.000	14.018	9.964	10.000
JSM-1214-06	12.0	14.0	6.0	12.032	12.102	14.000	14.018	11.957	12.000
JSM-1214-08	12.0	14.0	8.0			14.000	14.018	11.957	12.000
JSM-1214-09	12.0	14.0	9.0			14.000	14.018	11.957	12.000
JSM-1214-10	12.0	14.0	10.0			14.000	14.018	11.957	12.000
JSM-1214-12	12.0	14.0	12.0			14.000	14.018	11.957	12.000
JSM-1214-15	12.0	14.0	15.0			14.000	14.018	11.957	12.000
JSM-1214-20	12.0	14.0	20.0			14.000	14.018	11.957	12.000
JSM-1216-12	12.0	16.0	12.0			12.050	12.160	16.000	16.018
JSM-1216-17	12.0	16.0	17.0	16.000	16.018			11.957	12.000
JSM-1315-10	13.0	15.0	10.0	13.032	13.102	15.000	15.018	12.957	13.000
JSM-1315-20	13.0	15.0	20.0			15.000	15.018	12.957	13.000
JSM-1316-185	13.0	16.0	18.5			16.000	16.018	12.957	13.000
JSM-1416-05	14.0	16.0	5.0	14.032	14.102	16.000	16.018	13.957	14.000
JSM-1416-08	14.0	16.0	8.0			16.000	16.018	13.957	14.000
JSM-1416-10	14.0	16.0	10.0			16.000	16.018	13.957	14.000
JSM-1416-15	14.0	16.0	15.0			16.000	16.018	13.957	14.000
JSM-1416-20	14.0	16.0	20.0			16.000	16.018	13.957	14.000
JSM-1416-25	14.0	16.0	25.0			16.000	16.018	13.957	14.000
JSM-1418-18	14.0	18.0	18.0			18.000	18.018	13.957	14.000
JSM-1420-20	14.0	20.0	20.0	14.050	14.160	20.000	20.021	13.957	14.000
JSM-1517-06	15.0	17.0	6.0	15.032	15.102	17.000	17.018	14.957	15.000
JSM-1517-10	15.0	17.0	10.0			17.000	17.018	14.957	15.000
JSM-1517-12	15.0	17.0	12.0			17.000	17.018	14.957	15.000
JSM-1517-15	15.0	17.0	15.0			17.000	17.018	14.957	15.000
JSM-1517-20	15.0	17.0	20.0			17.000	17.018	14.957	15.000
JSM-1517-25	15.0	17.0	25.0			17.000	17.018	14.957	15.000
JSM-1518-10	15.0	18.0	10.0			18.000	18.018	14.957	15.000

Part Number	d1	d2	b1	I.D. After Pressfit*		Housing Bore		Shaft Size	
				Min.	Max.	Min.	Max.	Min.	Max.
JSM-1618-10	16.0	18.0	10.0	16.032	16.102	18.000	18.018	15.957	16.000
JSM-1618-12	16.0	18.0	12.0			18.000	18.018	15.957	16.000
JSM-1618-15	16.0	18.0	15.0			18.000	18.018	15.957	16.000
JSM-1618-20	16.0	18.0	20.0			18.000	18.018	15.957	16.000
JSM-1618-25	16.0	18.0	25.0			18.000	18.018	15.957	16.000
JSM-1620-16	16.0	20.0	16.0	16.050	16.160	20.000	20.021	15.957	16.000
JSM-1622-16	16.0	22.0	16.0			22.000	22.021	15.957	16.000
JSM-1622-20	16.0	22.0	20.0			22.000	22.021	15.957	16.000
JSM-1719-06	17.0	19.0	6.0	17.032	17.102	19.000	19.021	16.957	17.000
JSM-1820-10	18.0	20.0	10.0	18.032	18.102	20.000	20.021	17.957	18.000
JSM-1820-15	18.0	20.0	15.0			20.000	20.021	17.957	18.000
JSM-1820-20	18.0	20.0	20.0			20.000	20.021	17.957	18.000
JSM-1820-25	18.0	20.0	25.0			20.000	20.021	17.957	18.000
JSM-1922-14	19.0	22.0	14.0	19.032	19.102	22.000	22.021	18.948	19.000
JSM-2022-20	20.0	22.0	20.0	20.040	20.124	22.000	22.021	19.948	20.000
JSM-2022-30	20.0	22.0	30.0			22.000	22.021	19.948	20.000
JSM-2023-10	20.0	23.0	10.0			23.000	23.021	19.948	20.000
JSM-2023-15	20.0	23.0	15.0			23.000	23.021	19.948	20.000
JSM-2023-20	20.0	23.0	20.0			23.000	23.021	19.948	20.000
JSM-2023-25	20.0	23.0	25.0			23.000	23.021	19.948	20.000
JSM-2023-30	20.0	23.0	30.0			23.000	23.021	19.948	20.000
JSM-2026-06	20.0	26.0	6.0	20.065	20.195	26.000	26.021	19.948	20.000
JSM-2026-20	20.0	26.0	20.0			26.000	26.021	19.948	20.000
JSM-2026-25	20.0	26.0	25.0			26.000	26.021	19.948	20.000
JSM-2026-30	20.0	26.0	30.0			26.000	26.021	19.948	20.000
JSM-2124-12	21.0	24.0	12.0	21.040	21.124	24.000	24.021	20.948	21.000
JSM-2225-15	22.0	25.0	15.0	22.040	22.124	25.000	25.021	21.948	22.000
JSM-2225-20	22.0	25.0	20.0			25.000	25.021	21.948	22.000
JSM-2225-25	22.0	25.0	25.0			25.000	25.021	21.948	22.000
JSM-2225-30	22.0	25.0	30.0			25.000	25.021	21.948	22.000
JSM-2228-20	22.0	28.0	20.0	22.065	22.195	28.000	28.021	21.948	22.000
JSM-2326-12	23.0	26.0	12.0	23.040	23.124	26.000	26.021	22.948	23.000
JSM-2427-15	24.0	27.0	15.0	24.040	24.124	27.000	27.021	23.948	24.000
JSM-2427-20	24.0	27.0	20.0			27.000	27.021	23.948	24.000
JSM-2427-25	24.0	27.0	25.0			27.000	27.021	23.948	24.000
JSM-2427-30	24.0	27.0	30.0			27.000	27.021	23.948	24.000
JSM-2427-46	24.0	27.0	46.0			27.000	27.021	23.948	24.000
JSM-2528-12	25.0	28.0	12.0	25.040	25.124	28.000	28.021	24.948	25.000
JSM-2528-15	25.0	28.0	15.0			28.000	28.021	24.948	25.000
JSM-2528-20	25.0	28.0	20.0			28.000	28.021	24.948	25.000
JSM-2528-25	25.0	28.0	25.0			28.000	28.021	24.948	25.000
JSM-2528-30	25.0	28.0	30.0			28.000	28.021	24.948	25.000
JSM-2528-60	25.0	28.0	60.0			28.000	28.021	24.948	25.000
JSM-2530-40	25.0	30.0	40.0	25.065	25.195	30.000	30.021	24.948	25.000
JSM-2532-25	25.0	32.0	25.0			32.000	32.025	24.948	25.000
JSM-2532-32	25.0	32.0	32.0			32.000	32.025	24.948	25.000
JSM-2532-35	25.0	32.0	35.0			32.000	32.025	24.948	25.000

# Bearing technology | Plain bearing | iglide® J

## Sleeve bearing (form S), metric

Part Number	d1	d2	b1	I.D. After Pressfit*		Housing Bore		Shaft Size	
				Min.	Max.	Min.	Max.	Min.	Max.
JSM-2630-20	26.0	30.0	20.0	26.065	26.195	30.000	30.021	25.948	26.000
JSM-2730-20	27.0	30.0	20.0	27.040	27.124	30.000	30.021	26.948	27.000
JSM-2832-20	28.0	32.0	20.0	28.065	28.195	32.000	32.025	27.948	28.000
JSM-2832-25	28.0	32.0	25.0			32.000	32.025	27.948	28.000
JSM-2832-30	28.0	32.0	30.0			32.000	32.025	27.948	28.000
JSM-3034-20	30.0	34.0	20.0	30.040	30.124	34.000	34.025	29.948	30.000
JSM-3034-25	30.0	34.0	25.0			34.000	34.025	29.948	30.000
JSM-3034-30	30.0	34.0	30.0			34.000	34.025	29.948	30.000
JSM-3034-40	30.0	34.0	40.0			34.000	34.025	29.948	30.000
JSM-3038-40	30.0	38.0	40.0	30.065	30.195	38.000	38.025	29.948	30.000
JSM-3236-20	32.0	36.0	20.0	32.050	32.150	36.000	36.025	31.938	32.000
JSM-3236-30	32.0	36.0	30.0			36.000	36.025	31.938	32.000
JSM-3236-40	32.0	36.0	40.0			36.000	36.025	31.938	32.000
JSM-3237-25	32.0	37.0	25.0			37.000	37.025	31.938	32.000
JSM-3238-50	32.0	38.0	50.0	32.080	32.240	38.000	38.025	31.938	32.000
JSM-3539-20	35.0	39.0	20.0	35.050	35.150	39.000	39.025	34.938	35.000
JSM-3539-30	35.0	39.0	30.0			39.000	39.025	34.938	35.000
JSM-3539-40	35.0	39.0	40.0			39.000	39.025	34.938	35.000
JSM-3539-50	35.0	39.0	50.0			39.000	39.025	34.938	35.000
JSM-3640-45	36.0	40.0	45.0	36.050	36.150	40.000	40.025	35.938	36.000
JSM-4044-20	40.0	44.0	20.0	40.050	40.150	44.000	44.025	39.938	40.000
JSM-4044-30	40.0	44.0	30.0			44.000	44.025	39.938	40.000
JSM-4044-35	40.0	44.0	35.0			44.000	44.025	39.938	40.000
JSM-4044-40	40.0	44.0	40.0			44.000	44.025	39.938	40.000
JSM-4044-50	40.0	44.0	50.0			44.000	44.025	39.938	40.000
JSM-4246-73	42.0	46.0	73.0	42.080	42.240	46.000	46.025	41.938	42.000
JSM-4550-20	45.0	50.0	20.0	45.050	45.150	50.000	50.025	44.938	45.000
JSM-4550-30	45.0	50.0	30.0			50.000	50.025	44.938	45.000
JSM-4550-40	45.0	50.0	40.0			50.000	50.025	44.938	45.000
JSM-4550-50	45.0	50.0	50.0			50.000	50.025	44.938	45.000
JSM-5055-20	50.0	55.0	20.0	50.050	50.150	55.000	55.030	49.938	50.000
JSM-5055-30	50.0	55.0	30.0			55.000	55.030	49.938	50.000
JSM-5055-40	50.0	55.0	40.0			55.000	55.030	49.938	50.000
JSM-5055-50	50.0	55.0	50.0			55.000	55.030	49.938	50.000
JSM-5055-60	50.0	55.0	60.0			55.000	55.030	49.938	50.000
JSM-5560-60	55.0	60.0	60.0	55.060	55.180	60.000	60.030	54.926	55.000
JSM-6065-60	60.0	65.0	60.0	60.060	60.180	65.000	65.030	59.926	60.000
JSM-6570-50	65.0	70.0	50.0	65.060	65.180	70.000	70.030	64.926	65.000
JSM-7075-60	70.0	75.0	60.0	70.060	70.180	75.000	75.030	69.926	70.000
JSM-7580-60	75.0	80.0	60.0	75.060	75.180	80.000	80.030	74.926	75.000
JSM-8085-100	80.0	85.0	100.0	80.060	80.180	85.000	85.035	79.926	80.000
JSM-8086-60	80.0	86.0	60.0			86.000	86.035	79.926	80.000
JSM-100105-100	100.0	105.0	100.0	100.072	100.212	105.000	105.035	99.913	100.000
JSM-110115-60	110.0	115.0	60.0	110.072	110.212	115.000	115.035	109.913	110.000

## Flange bearing (form F), metric

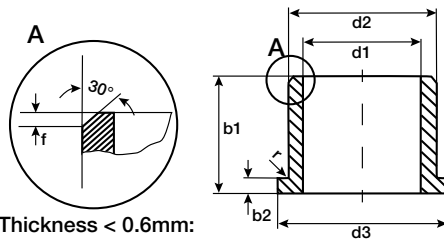

<sup>2)</sup> Thickness < 0.6mm:  
Chamfer = 20°

For tolerance values, page 196

### Order key

Type: **J F M -03 04 -03**

iglide® material	Form F (flange)	Metric	Inner Ø d1 (mm)	Outer Ø d2 (mm)	Length b1 (mm)
------------------	-----------------	--------	-----------------	-----------------	----------------

**i** Dimensions according to ISO 3547-1 and special dimensions

#### Chamfer in relation to d1

d1 [mm]	Ø 1-6	Ø >6-12	Ø >12-30	Ø > 30
f [mm]	0.3	0.5	0.8	1.2

\*Based on steel housing bore

Part Number	d1 <sup>1)</sup>	d2	d3	b1	b2	I.D. After Pressfit*		Housing Bore		Shaft Size	
						Min.	Max.	Min.	Max.	Min.	Max.
JFM-0304-03	3.0	4.5	7.5	3.0	0.75	3.014	3.054	4.500	4.512	2.975	3.000
JFM-0304-045	3.0	4.5	7.5	4.5	0.75			4.500	4.512	2.975	3.000
JFM-0304-05	3.0	4.5	7.5	5.0	0.75			4.500	4.512	2.975	3.000
JFM-0306-10	3.0	6.0	9.0	10.0	1.50	3.020	3.080	6.000	6.012	2.975	3.000
JFM-0405-03	4.0	5.5	9.5	3.0	0.75	4.020	4.068	5.500	5.512	3.970	4.000
JFM-0405-06	4.0	5.5	9.5	6.0	0.75			5.500	5.512	3.970	4.000
JFM-0506-05	5.0	6.0	10.0	5.0	0.50	5.020	5.068	6.000	6.012	4.970	5.000
JFM-0507-03	5.0	7.0	11.0	3.0	1.00			7.000	7.015	4.970	5.000
JFM-0507-05	5.0	7.0	11.0	5.0	1.00			7.000	7.015	4.970	5.000
JFM-0608-04	6.0	8.0	12.0	4.0	1.00	6.020	6.068	8.000	8.015	5.970	6.000
JFM-0608-06	6.0	8.0	12.0	6.0	1.00			8.000	8.015	5.970	6.000
JFM-0608-08	6.0	8.0	12.0	8.0	1.00			8.000	8.015	5.970	6.000
JFM-0608-10	6.0	8.0	12.0	10.0	1.00			8.000	8.015	5.970	6.000
JFM-0610-10	6.0	10.0	14.0	10.0	2.00	6.030	6.105	10.000	10.015	5.970	6.000
JFM-0810-038	8.0	10.0	15.0	3.8	1.00	8.025	8.083	10.000	10.015	7.964	8.000
JFM-0810-05	8.0	10.0	15.0	5.0	1.00			10.000	10.015	7.964	8.000
JFM-0810-06	8.0	10.0	15.0	6.0	1.00			10.000	10.015	7.964	8.000
JFM-0810-07	8.0	10.0	15.0	7.0	1.00			10.000	10.015	7.964	8.000
JFM-0810-08	8.0	10.0	15.0	8.0	1.00			10.000	10.015	7.964	8.000
JFM-0810-09	8.0	10.0	15.0	9.5	1.00			10.000	10.015	7.964	8.000
JFM-0810-10	8.0	10.0	15.0	10.0	1.00			10.000	10.015	7.964	8.000
JFM-081012-16	8.0	10.0	12.0	16.0	1.00			10.000	10.015	7.964	8.000
JFM-0810125-10	8.0	10.0	12.5	10.0	1.00			10.000	10.015	7.964	8.000
JFM-081014-10	8.0	10.0	14.0	10.0	1.00			10.000	10.015	7.964	8.000
JFM-081016-11	8.0	10.0	16.0	11.0	2.00	10.000	10.015	7.964	8.000		
JFM-0812-05	8.0	12.0	16.0	16.0	1.00	8.040	8.130	10.000	10.015	7.964	8.000
JFM-0812-06	8.0	12.0	16.0	6.0	2.00	8.025	8.115	12.000	12.018	7.964	8.000
JFM-0812-09	8.0	12.0	16.0	9.0	2.00			12.000	12.018	7.964	8.000
JFM-0812-12	8.0	12.0	16.0	12.0	1.00			12.000	12.018	7.964	8.000
JFM-0812-30	8.0	12.0	16.0	30.0	2.00			12.000	12.018	7.964	8.000
JFM-1012-05	10.0	12.0	18.0	5.0	1.00	10.025	10.083	12.000	12.018	9.964	10.000
JFM-1012-07	10.0	12.0	18.0	7.0	1.00			12.000	12.018	9.964	10.000
JFM-1012-09	10.0	12.0	18.0	9.0	1.00			12.000	12.018	9.964	10.000
JFM-1012-10	10.0	12.0	18.0	10.0	1.00			12.000	12.018	9.964	10.000
JFM-1012-12	10.0	12.0	18.0	12.0	1.00			12.000	12.018	9.964	10.000



## Flange bearing (form F), metric

Part Number	d1 <sup>1)</sup>	d2	d3	b1	b2	I.D. After Pressfit*		Housing Bore		Shaft Size	
			d13	h13	-0.14	Min.	Max.	Min.	Max.	Min.	Max.
JFM-1012-15	10.0	12.0	18.0	15.0	1.00	10.025	10.083	12.000	12.018	9.964	10.000
JFM-1012-17	10.0	12.0	18.0	17.0	1.00			12.000	12.018	9.964	10.000
JFM-1012-18	10.0	12.0	18.0	18.0	1.00			12.000	12.018	9.964	10.000
JFM-101215-035	10.0	12.0	15.0	3.5	1.00			12.000	12.018	9.964	10.000
JFM-1014-14	10.0	14.0	17.5	14.0	1.00			14.000	14.018	9.964	10.000
JFM-1016-10	10.0	16.0	22.0	10.0	3.00	10.040	10.130	16.000	16.018	9.964	10.000
JFM-1016-16	10.0	16.0	22.0	16.0	3.00			16.000	16.018	9.964	10.000
JFM-1113-05	11.0	13.0	18.0	5.0	1.00	11.032	11.102	13.000	13.018	10.957	11.000
JFM-1214-04	12.0	14.0	20.0	4.0	1.00	12.032	12.102	14.000	14.018	11.957	12.000
JFM-1214-05	12.0	14.0	20.0	5.0	1.00			14.000	14.018	11.957	12.000
JFM-1214-07	12.0	14.0	20.0	7.0	1.00			14.000	14.018	11.957	12.000
JFM-1214-09	12.0	14.0	20.0	9.0	1.00			14.000	14.018	11.957	12.000
JFM-1214-12	12.0	14.0	20.0	12.0	1.00			14.000	14.018	11.957	12.000
JFM-1214-15	12.0	14.0	20.0	15.0	1.00			14.000	14.018	11.957	12.000
JFM-1214-17	12.0	14.0	20.0	17.0	1.00			14.000	14.018	11.957	12.000
JFM-1214-20	12.0	14.0	20.0	20.0	1.00			14.000	14.018	11.957	12.000
JFM-121418-045	12.0	14.0	18.0	4.5	1.00			14.000	14.018	11.957	12.000
JFM-121418-10	12.0	14.0	18.0	10.0	1.00			14.000	14.018	11.957	12.000
JFM-1218-08	12.0	18.0	24.0	8.0	3.00			12.050	12.160	18.000	18.018
JFM-1218-12	12.0	18.0	24.0	12.0	3.00	18.000	18.018			11.957	12.000
JFM-1218-20	12.0	18.0	22.0	20.0	3.00	18.000	18.018			11.957	12.000
JFM-1416-03	14.0	16.0	22.0	3.0	1.00	14.032	14.102	16.000	16.018	13.957	14.000
JFM-1416-10	14.0	16.0	22.0	10.0	1.00			16.000	16.018	13.957	14.000
JFM-1416-12	14.0	16.0	22.0	12.0	1.00			16.000	16.018	13.957	14.000
JFM-1416-17	14.0	16.0	22.0	17.0	1.00			16.000	16.018	13.957	14.000
JFM-141822-20	14.0	18.0	22.0	20.0	2.00			18.000	18.018	13.957	14.000
JFM-141825-24	14.0	18.0	25.0	24.0	2.00			18.000	18.018	13.957	14.000
JFM-1420-20	14.0	20.0	25.0	20.0	3.00	14.050	14.160	20.000	20.021	13.957	14.000
JFM-1517-04	15.0	17.0	23.0	4.0	1.00	15.032	15.102	17.000	17.018	14.957	15.000
JFM-1517-055	15.0	17.0	23.0	5.5	1.00			17.000	17.018	14.957	15.000
JFM-1517-09	15.0	17.0	23.0	9.0	1.00			17.000	17.018	14.957	15.000
JFM-1517-12	15.0	17.0	23.0	12.0	1.00			17.000	17.018	14.957	15.000
JFM-1517-17	15.0	17.0	23.0	17.0	1.00			17.000	17.018	14.957	15.000
JFM-1521-20	15.0	21.0	27.0	20.0	3.00	15.050	15.160	21.000	21.021	14.957	15.000
JFM-1618-06	16.0	18.0	24.0	6.0	1.00	16.032	16.102	18.000	18.018	15.957	16.000
JFM-1618-12	16.0	18.0	24.0	12.0	1.00			18.000	18.018	15.957	16.000
JFM-1618-16	16.0	18.0	24.0	16.0	1.00			18.000	18.018	15.957	16.000
JFM-1618-17	16.0	18.0	24.0	17.0	1.00			18.000	18.018	15.957	16.000
JFM-1622-12	16.0	22.0	28.0	12.0	3.00	16.050	16.160	22.000	22.021	15.957	16.000
JFM-1622-15	16.0	22.0	28.0	15.0	3.00			22.000	22.021	15.957	16.000
JFM-1622-20	16.0	22.0	28.0	20.0	3.00			22.000	22.021	15.957	16.000
JFM-1622-25	16.0	22.0	28.0	25.0	3.00			22.000	22.021	15.957	16.000
JFM-1719-09	17.0	19.0	25.0	9.0	1.00	17.032	17.102	19.000	19.021	16.957	17.000
JFM-1719-21	17.0	19.0	25.0	21.0	1.00			19.000	19.021	16.957	17.000
JFM-1820-04	18.0	20.0	26.0	4.0	1.00	18.032	18.102	20.000	20.021	17.957	18.000
JFM-1820-12	18.0	20.0	26.0	12.0	1.00			20.000	20.021	17.957	18.000
JFM-1820-17	18.0	20.0	26.0	17.0	1.00			20.000	20.021	17.957	18.000

Part Number	d1 <sup>1)</sup>	d2	d3	b1	b2	I.D. After Pressfit*		Housing Bore		Shaft Size	
						Min.	Max.	Min.	Max.	Min.	Max.
JFM-1820-22	18.0	20.0	26.0	22.0	1.00	18.032	18.102	20.000	20.021	17.957	18.000
JFM-1821-12	18.0	21.0	25.0	12.0	1.00			21.000	21.021	17.957	18.000
JFM-1922-23	19.0	22.0	26.0	23.0	1.00	19.032	19.102	22.000	22.021	18.948	19.000
JFM-1922-36	19.0	22.0	26.0	36.0	1.00			22.000	22.021	18.948	19.000
JFM-2023-11	20.0	23.0	30.0	11.5	1.50	20.040	20.124	23.000	23.021	19.948	20.000
JFM-2023-15.5	20.0	23.0	30.0	15.5	1.50			23.000	23.021	19.948	20.000
JFM-2023-16	20.0	23.0	30.0	16.5	1.50			23.000	23.021	19.948	20.000
JFM-2023-21	20.0	23.0	30.0	21.5	1.50			23.000	23.021	19.948	20.000
JFM-2026-15	20.0	26.0	32.0	15.0	3.00	20.065	20.195	26.000	26.021	19.948	20.000
JFM-2026-20	20.0	26.0	32.0	20.0	3.00			26.000	26.021	19.948	20.000
JFM-2026-25	20.0	26.0	32.0	25.0	3.00			26.000	26.021	19.948	20.000
JFM-2026-30	20.0	26.0	32.0	30.0	3.00			26.000	26.021	19.948	20.000
JFM-222532-08	22.0	25.0	32.0	8.0	1.50	22.040	22.124	25.000	25.021	21.948	22.000
JFM-2430-30	24.0	30.0	36.0	30.0	3.00	24.040	24.124	30.000	30.021	23.948	24.000
JFM-2528-06	25.0	28.0	35.0	6.0	1.50	25.040	25.124	28.000	28.021	24.948	25.000
JFM-2528-11	25.0	28.0	35.0	11.5	1.50			28.000	28.021	24.948	25.000
JFM-2528-12	25.0	28.0	35.0	12.0	1.50			28.000	28.021	24.948	25.000
JFM-2528-14.5	25.0	28.0	35.0	14.5	1.50			28.000	28.021	24.948	25.000
JFM-2528-21	25.0	28.0	35.0	21.5	1.50			28.000	28.021	24.948	25.000
JFM-252839-05	25.0	28.0	39.0	5.0	1.50			28.000	28.021	24.948	25.000
JFM-252839-075	25.0	28.0	39.0	7.5	1.50	25.065	25.195	28.000	28.021	24.948	25.000
JFM-2532-20	25.0	32.0	38.0	20.0	4.00			32.000	32.025	24.948	25.000
JFM-2532-25	25.0	32.0	38.0	25.0	4.00			32.000	32.025	24.948	25.000
JFM-2532-40	25.0	32.0	38.0	40.0	2.00	28.065	28.195	32.000	32.021	24.948	25.000
JFM-283235-07	28.0	32.0	35.0	7.0	2.00			32.000	32.025	27.948	28.000
JFM-283239-20	28.0	32.0	39.0	20.0	2.00	28.040	28.124	32.000	32.025	27.948	28.000
JFM-303240-12	30.0	32.0	40.0	12.0	1.00	30.040	30.124	32.000	32.025	29.948	30.000
JFM-3034-16	30.0	34.0	42.0	16.0	2.00			34.000	34.025	29.948	30.000
JFM-3034-20	30.0	34.0	42.0	20.0	2.00			34.000	34.025	29.948	30.000
JFM-3034-26	30.0	34.0	42.0	26.0	2.00			34.000	34.025	29.948	30.000
JFM-3038-20	30.0	38.0	44.0	20.0	4.00	30.065	30.195	38.000	38.025	29.948	30.000
JFM-3038-30	30.0	38.0	44.0	30.0	4.00			38.000	38.025	29.948	30.000
JFM-3038-36	30.0	38.0	44.0	36.0	4.00			38.000	38.025	29.948	30.000
JFM-3539-12	35.0	39.0	47.0	12.0	2.00	35.050	35.150	39.000	39.025	34.938	35.000
JFM-3539-16	35.0	39.0	47.0	16.0	2.00			39.000	39.025	34.938	35.000
JFM-3539-26	35.0	39.0	47.0	26.0	2.00			39.000	39.025	34.938	35.000
JFM-4044-20	40.0	44.0	52.0	20.0	2.00	40.050	40.150	44.000	44.025	39.938	40.000
JFM-4044-30	40.0	44.0	52.0	30.0	2.00			44.000	44.025	39.938	40.000
JFM-4044-40	40.0	44.0	52.0	40.0	2.00			44.000	44.025	39.938	40.000
JFM-4550-12	45.0	50.0	58.0	12.0	2.00	45.050	45.150	50.000	50.025	44.938	45.000
JFM-4550-20	45.0	50.0	58.0	20.0	2.00			50.000	50.025	44.938	45.000
JFM-4550-50	45.0	50.0	58.0	50.0	2.00			50.000	50.025	44.938	45.000
JFM-5055-115	50.0	55.0	63.0	11.5	2.00	50.050	50.150	55.000	55.030	49.938	50.000
JFM-5055-50	50.0	55.0	63.0	50.0	2.00			55.000	55.030	49.938	50.000
JFM-5560-50	55.0	60.0	68.0	50.0	2.00	55.060	55.180	60.000	60.030	54.926	55.000
JFM-6065-37	60.0	65.0	73.0	37.0	2.00	60.060	60.180	65.000	65.030	59.926	60.000
JFM-6065-50	60.0	65.0	73.0	50.0	2.00			65.000	65.030	59.926	60.000

# Bearing technology | Plain bearing | iglide® J

## Flange bearing (form F), metric

Part Number	d1 <sup>1)</sup>	d2	d3	b1	b2	I.D. After Pressfit*		Housing Bore		Shaft Size	
			d13	h13	-0.14	Min.	Max.	Min.	Max.	Min.	Max.
JFM-6570-60	60.0	70.0	78.0	60.0	2.00	65.060	65.180	70.000	70.030	64.926	65.000
JFM-7075-50	70.0	75.0	83.0	50.0	2.00	70.060	70.180	75.000	75.030	69.926	70.000
JFM-9095-100	90.0	95.0	103.0	100.0	2.50	90.072	90.212	95.000	95.035	89.913	90.000
JFM-100105-100	100.0	105.0	113.0	100.0	2.50	100.072	100.212	105.000	105.035	99.913	100.000
JFM-110115-100	110.0	115.0	123.0	100.0	2.50	110.072	110.212	115.000	115.035	109.913	110.000
JFM-120125-100	120.0	125.0	133.0	100.0	2.50	120.072	120.212	125.000	125.040	119.913	120.000

# Bearing technology | Plain bearing | iglide® J

## Thrust washer bearing (form T), metric

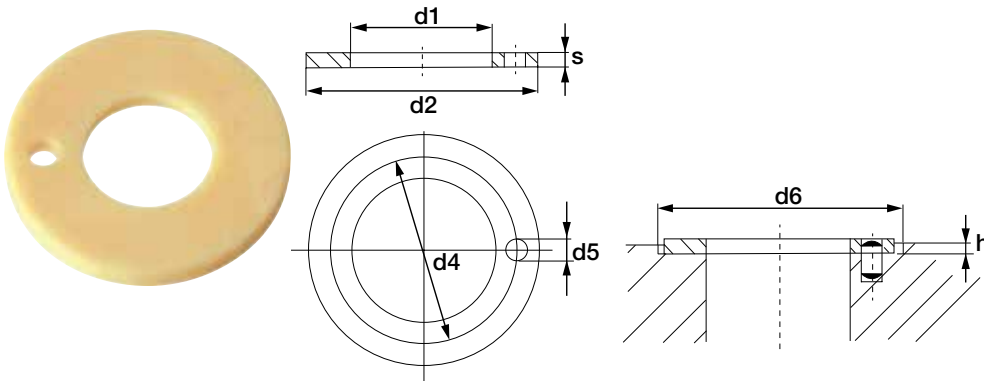

 **Order key**

Type	Dimensions
<b>J</b>	<b>T M -05 12-010</b>
iglide® material	Thrust washer
Metric	Inner Ø d1 (mm)
	Outer Ø d2 (mm)
	Thickness s (mm)

Part Number	d1	d2	s	d4	d5	h	d6
	+0.25	-0.25	-0.05	-0.12 +0.12	+0.375 +0.125	+0.2 -0.2	+0.12
JTM-0512-010	5.3	12	1.0	*	*	0.7	12
JTM-1224-015	12	24	1.5	18	1.5	1	24
JTM-1234-015	12	34	1.5	*	*	1	34
JTM-1420-015	14	20	1.5	*	*	1	20
JTM-2036-015	20	36	1.5	28	3	1	36
JTM-2842-020	28	42	2	35	3	1	42
JTM-3039-015	30	39	1.5	*	*	1	39
JTM-5670-010	56	70	1	*	*	0.7	70
JTM-139188-020	139	188	2	*	*	1.5	188

<sup>1)</sup> Design without fixing hole