

SERIES: PTP15 | **DESCRIPTION:** DC-DC CONVERTER

FEATURES

- up to 15W continuous power
- 2:1 input range (9~18, 18~36 and 36~75 Vdc)
- 5,600 Vdc isolation
- regulated single outputs
- certified to IEC/EN 60601-1
- EN 55011 Class A without external components
- -40 to +100 C operating temperature
- output over current, short circuit and over voltage protections

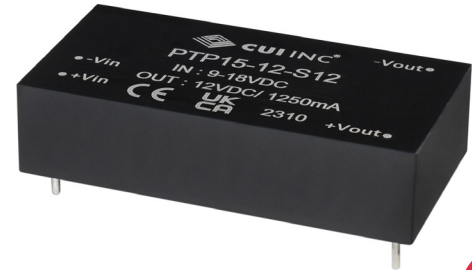

MODEL	input voltage		output voltage (Vdc)	output current max (mA)	output power max (W)	ripple and noise ¹ max (mVp-p)	efficiency ² typ (%)
	typ (Vdc)	range (Vdc)					
PTP15-12-S5	12	9~18	5	3,000	15	60	85
PTP15-12-S12	12	9~18	12	1,250	15	60	88
PTP15-12-S15	12	9~18	15	1,000	15	60	87
PTP15-12-S24	12	9~18	24	625	15	120	85
PTP15-24-S5	24	18~36	5	3,000	15	60	87
PTP15-24-S12	24	18~36	12	1,250	15	60	87
PTP15-24-S15	24	18~36	15	1,000	15	60	87
PTP15-24-S24	24	18~36	24	625	15	120	87
PTP15-48-S5	48	36~75	5	3,000	15	60	87
PTP15-48-S12	48	36~75	12	1,250	15	60	88
PTP15-48-S15	48	36~75	15	1,000	15	60	87
PTP15-48-S24	48	36~75	24	625	15	120	88

Note: 1. Measured at 20 MHz bandwidth with 0.1 µF capacitor.
 2. The efficiency is test by nominal input and max full load at 25°C, the tolerance for the efficiency measurement is plus and minus 2%~3%.
 3. All specifications are measured at Ta=25°C, nominal input voltage and full output load unless otherwise specified.

PART NUMBER KEY

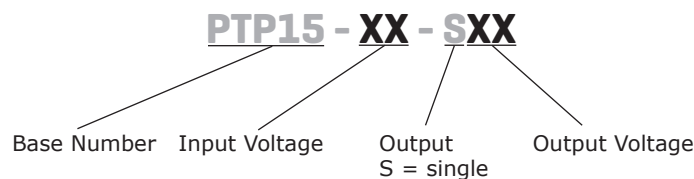

INPUT

parameter	conditions/description	min	typ	max	units
operating input voltage	12 Vdc input models	9	12	18	Vdc
	24 Vdc input models	18	24	36	Vdc
	48 Vdc input models	36	48	75	Vdc
current	12 Vdc input models, at no load		10		mA
	24 Vdc input models, at no load		7		mA
	48 Vdc input models, at no load		5		mA
under voltage lockout	12 Vdc input models		7.5		Vdc
	24 Vdc input models		15		Vdc
	48 Vdc input models		33		Vdc
surge voltage	at 1 second max				
	12 Vdc input models			25	Vdc
	24 Vdc input models			50	Vdc
	48 Vdc input models			100	Vdc
filter	pi filter				

OUTPUT

parameter	conditions/description	min	typ	max	units
capacitive load	5 Vdc output models			5,600	μF
	12 Vdc output models			1,000	μF
	15 Vdc output models			720	μF
	24 Vdc output models			220	μF
line regulation	input voltage from low to high, full load			±0.5	%
load regulation	0% to full load			±0.5	%
voltage accuracy				±1	%
start-up time	at nominal input, full load			25	ms
switching frequency	24 & 48 Vdc input, 5 Vdc output models		210		KHz
	12 & 24 Vdc input, all other output models		300		KHz
	48 Vdc input, all other output models		350		KHz
transient recovery time	75%~100% load step change			500	μs

PROTECTIONS

parameter	conditions/description	min	typ	max	units
over current protection			150		%
over voltage protection	output clamped with zener diode				
	5 Vdc output models	5.6		8.0	Vdc
	12 Vdc output models	13.4		19.2	Vdc
	15 Vdc output models	16.8		24.0	Vdc
	24 Vdc output models	26.9		38.4	Vdc
short circuit protection	auto recovery, continuous				

SAFETY AND COMPLIANCE

parameter	conditions/description	min	typ	max	units
isolation voltage		4,000			Vac
		5,600			Vdc
isolation capacitance				100	pF
isolation resistance		10,000			MΩ
safety approvals	certified to 60601-1: IEC, EN				
EMI ⁴	EN 55011 Class A				
ESD	EN 61000-4-2, Contact±8kV, Air±15kV, perf. Criteria A				
radiated immunity	EN 61000-4-3, 10V/m, perf. Criteria A				
fast transient ⁵	EN 61000-4-4, ±2kV, perf. Criteria A				

SAFETY AND COMPLIANCE

parameter	conditions/description	min	typ	max	units
surge ⁵	EN 61000-4-5, ±2kV, perf. Criteria A				
criteria immunity	EN 61000-4-6, 10 Vrms, perf. Criteria A				
magnetic field immunity	EN 61000-4-8, 10A/m, perf. Criteria A				
MTBF	as per MIL-HDBK-217F at 25°C at 51°C	1,060,000 84,000			hours hours
RoHS compliant	yes				

Note: 4. EMI Class A without external circuit.
5. Test with E-CAP 220µF/100V at input terminal.

ENVIRONMENTAL

parameter	conditions/description	min	typ	max	units
operating temperature	see derating curve	-40		100	°C
storage temperature		-55		105	°C
storage humidity	non-condensing	5		95	%

MECHANICAL

parameter	conditions/description	min	typ	max	units
dimensions	50.8 x 25.4 x 12.0				mm
weight			30		g
cooling method	natural convection				
case material	plastic case				
potting material	silicon				

MECHANICAL DRAWING

units: mm
tolerance: ±0.25 mm

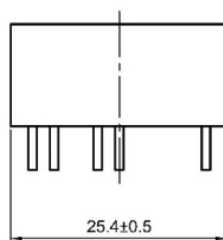
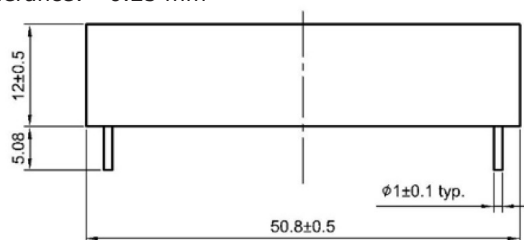

PIN CONNECTIONS	
PIN	Function
1	+Vin
2	-Vin
3	+Vout
4	no pin
5	-Vout

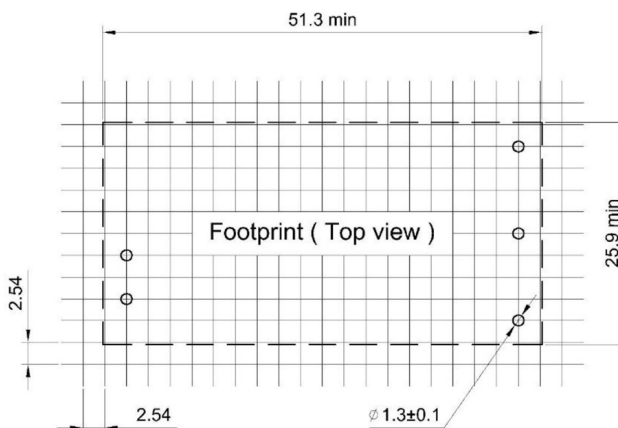
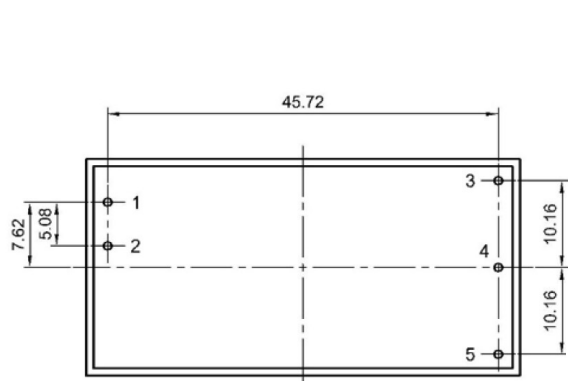

DERATING CURVES

**TEMPERATURE DERATING CURVE
(12 & 24 Vdc input models)**

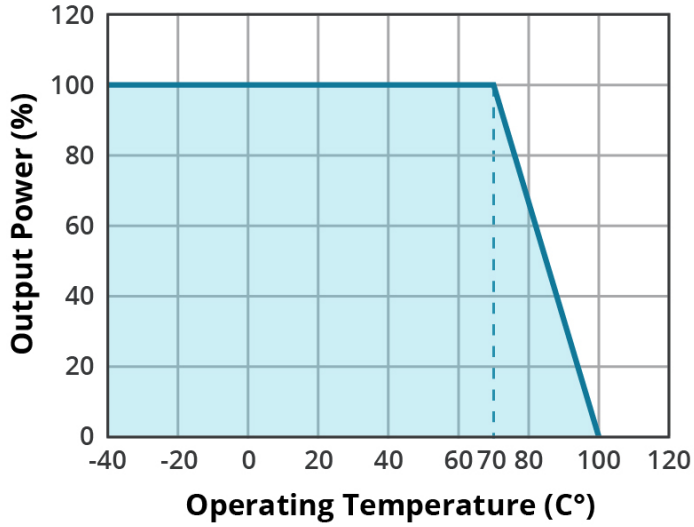

**TEMPERATURE DERATING CURVE
(48 Vdc input models)**

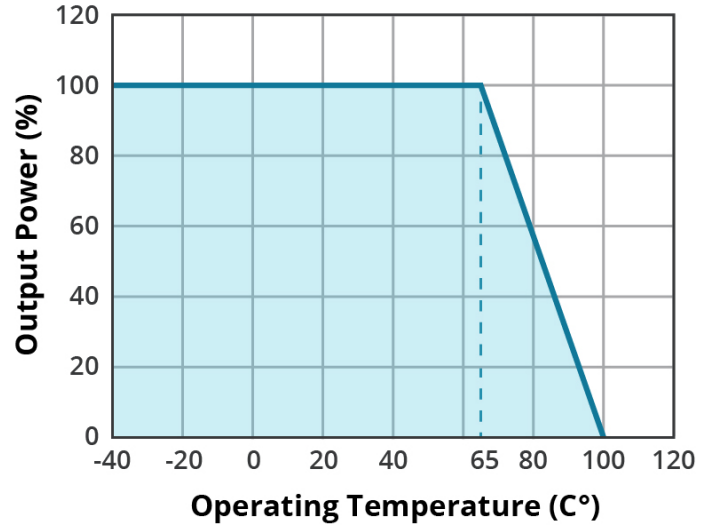

RIPPLE AND NOISE MEASURE

Figure 1

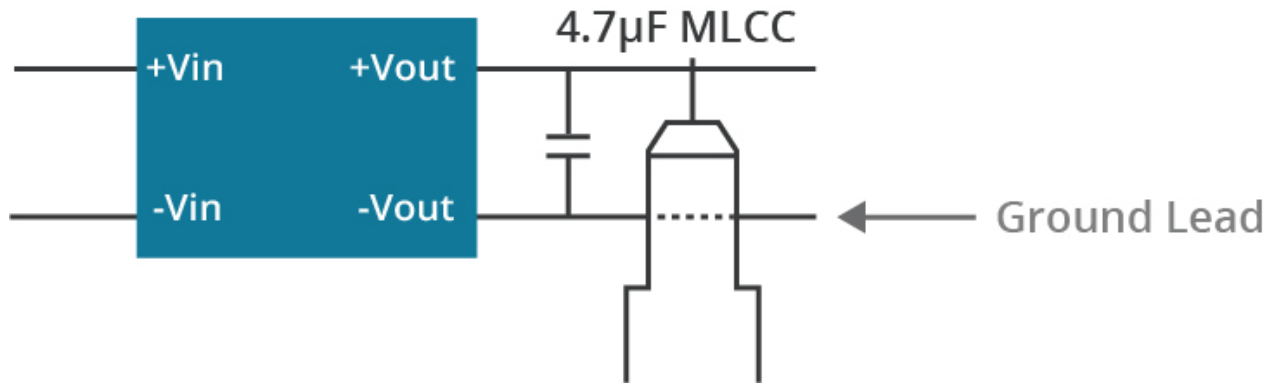

REVISION HISTORY

rev.	description	date
1.0	initial release	09/07/2023
1.01	company address updated	11/05/2024

The revision history provided is for informational purposes only and is believed to be accurate.



CUI INC

a bel group

Headquarters

15575 SW Sequoia Pkwy #100
Portland, OR 97224
800.275.4899

Fax 503.612.2383
cui.com
techsupport@cui.com

CUI offers a two (2) year limited warranty. Complete warranty information is listed on our website.

CUI reserves the right to make changes to the product at any time without notice. Information provided by CUI is believed to be accurate and reliable. However, no responsibility is assumed by CUI for its use, nor for any infringements of patents or other rights of third parties which may result from its use.

CUI products are not authorized or warranted for use as critical components in equipment that requires an extremely high level of reliability. A critical component is any component of a life support device or system whose failure to perform can be reasonably expected to cause the failure of the life support device or system, or to affect its safety or effectiveness.