



**Product Name: WiFi/Bluetooth Chip Antenna – CW801S**

**Part Number: H2U36G1L1B0100**

**Features:**

- Supporting WiFi/Bluetooth, covering 2400 to 2500 MHz
- Stable and reliable in performances
- Low profile, compact size
- RoHS 2.0 compliance
- SMT processes compatible
- AEC-Q200 compliant

**Applications:**

- ISM 2.4 GHz applications
- ZigBee/BLE applications
- Bluetooth earphone systems
- Hand-held devices when WiFi / Bluetooth functions are needed
- Smart phones
- IEEE802.11 b/g/n
- Wireless PCMCIA cards or USB dongles



# WiFi/Bluetooth Chip Antenna

**MODEL: CW801S**

Version: E

## I. Specifications:

Items	Specifications		
<b>Frequencies (MHz)</b>	2400~2500		
<b>Clearance area</b>	10 x 5 mm	10 x 4 mm	10 x 3 mm
<b>Return loss (dB)</b>	< -10 Typ.	< -10 Typ.	< -10 Typ.
<b>Efficiency (%)</b>	68 Typ.	67 Typ.	63 Typ.
<b>Average Gain (dB)</b>	-1.7 Typ.	-1.7 Typ.	-2.0 Typ.
<b>Peak Gain (dBi)</b>	0.8 Typ.	0.5 Typ.	0.9 Typ.
<b>Test Condition</b>	40 x 10 mm <sup>2</sup> (Evaluation board)		
<b>Impedance (Ω)</b>	50		
<b>Polarization</b>	Linear Polarization		

Mechanical Specifications	
<b>Dimensions (mm)</b>	8.0 (L) x 1.0 (W) x 0.5 (H)
<b>Material</b>	Ceramic
Environmental Conditions	
<b>Operation &amp; Storage Temperature (°C)</b>	-40 ~ +85
<b>Storage Temperature (°C) (Antenna with packing sealed)</b>	-5 ~ +40
<b>Relative Humidity</b>	10 ~ 70 %

© Unictron Technologies Corp.  
All specifications subject to change without notice.



## II. Layout Guide (unit : mm):

### Solder Land Pattern:

The solder land pattern (gold marking areas) is shown below. Recommendation on matching circuit will be provided according to customer's installation conditions.

© Unictron Technologies Corp.  
All specifications subject to change without notice.

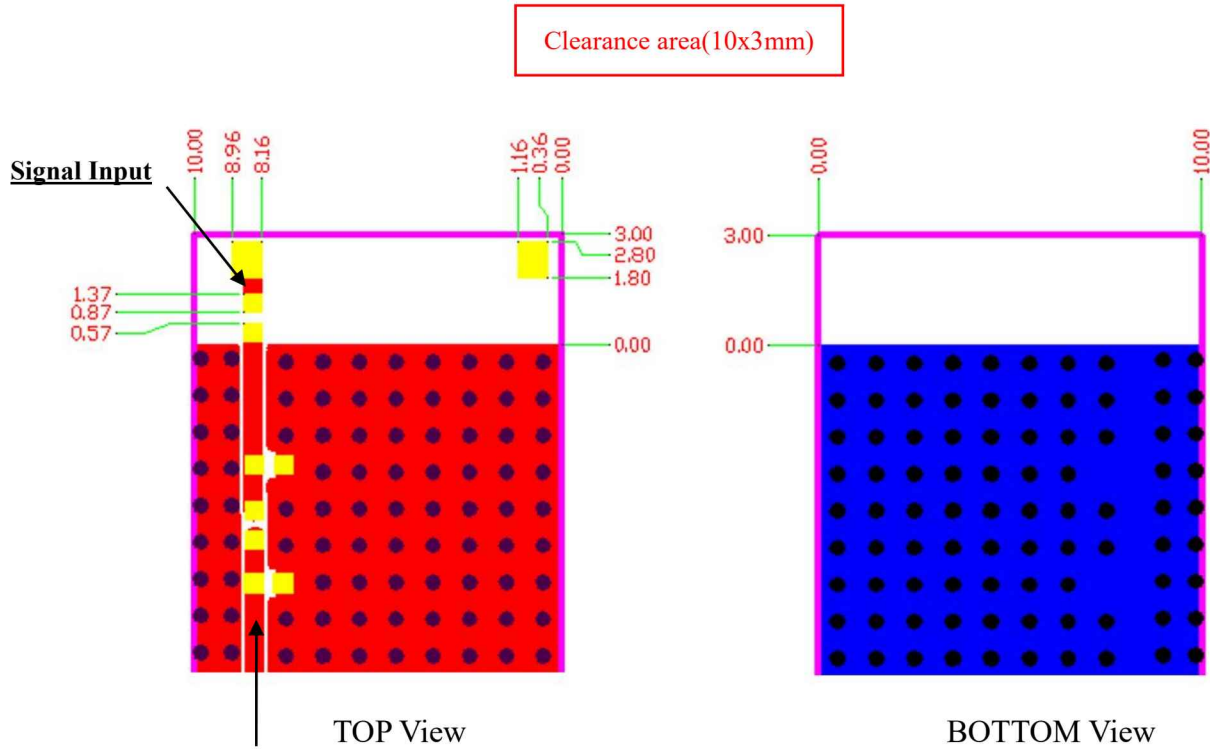

### Transmission Line with 50Ω Impedance Characteristic

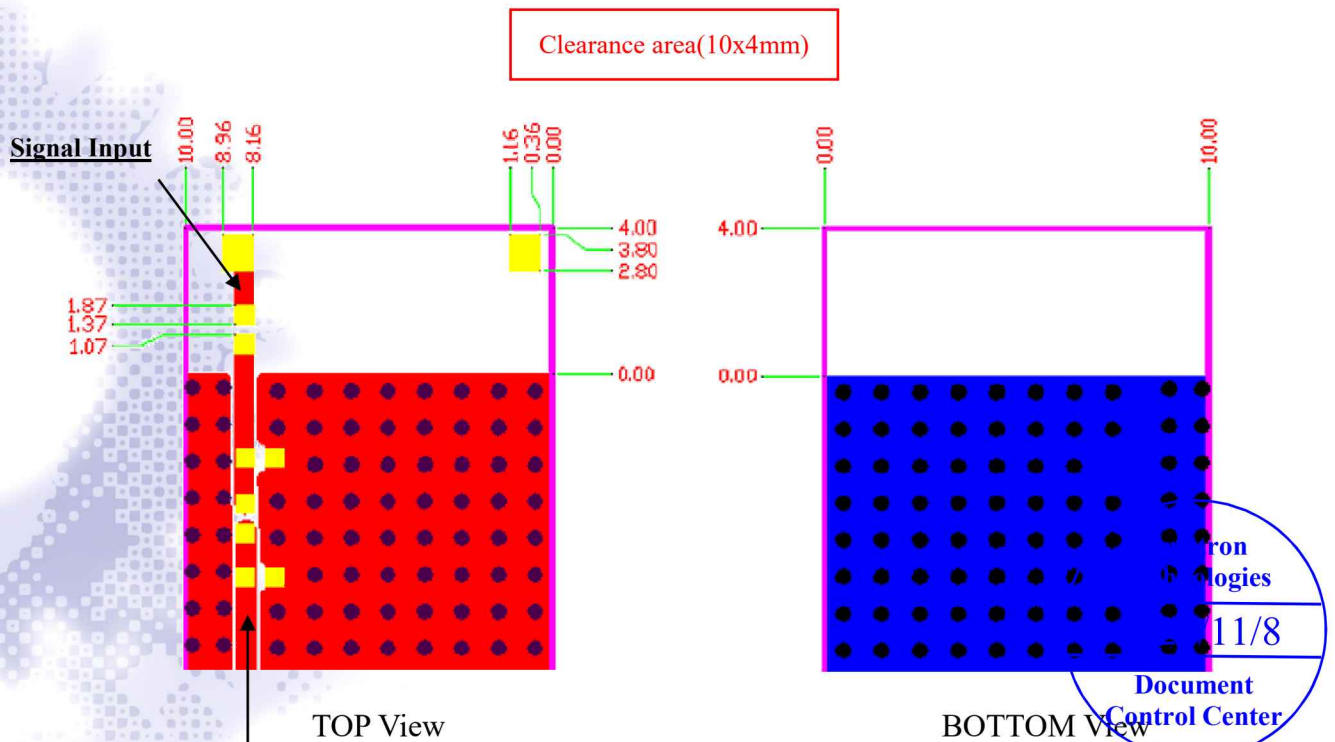

### Transmission Line with 50Ω Impedance Characteristic

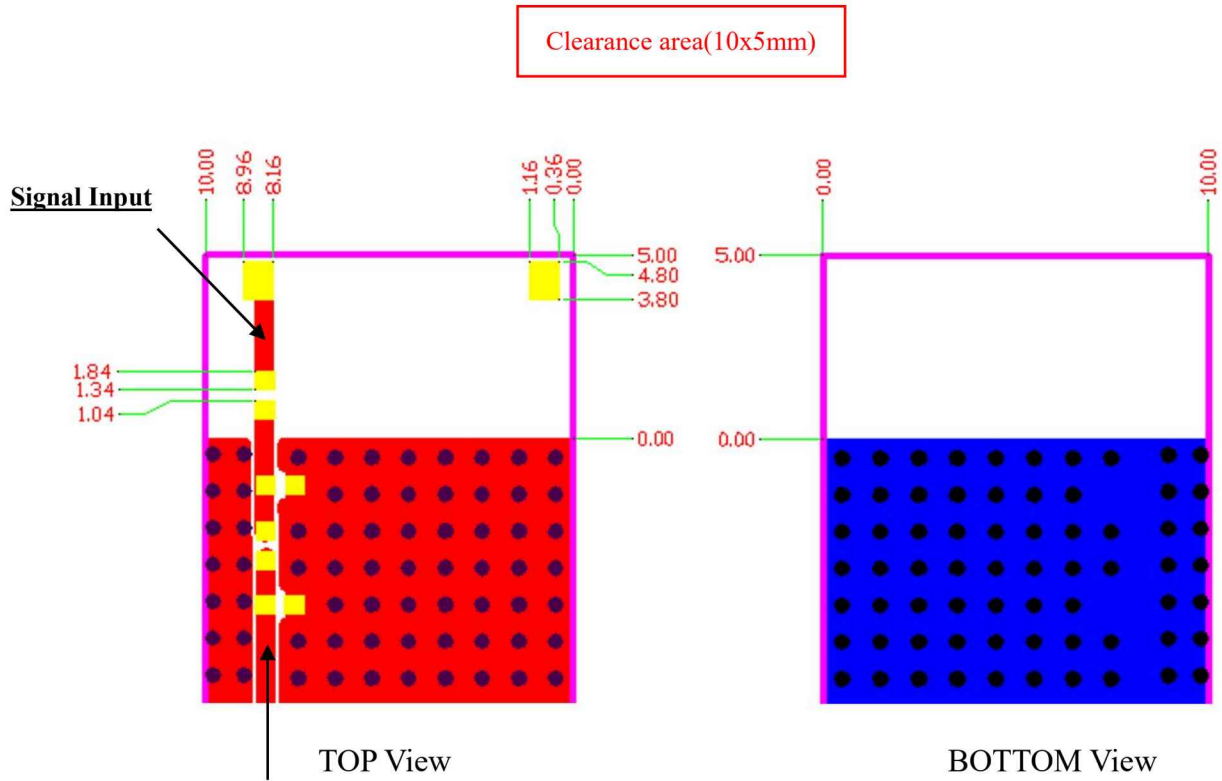

© Unictron Technologies Corp.  
All specifications subject to change without notice.

**Transmission Line with 50Ω Impedance Characteristic**



### III. Mechanical Dimensions (unit : mm):

#### a) Antenna Dimensions

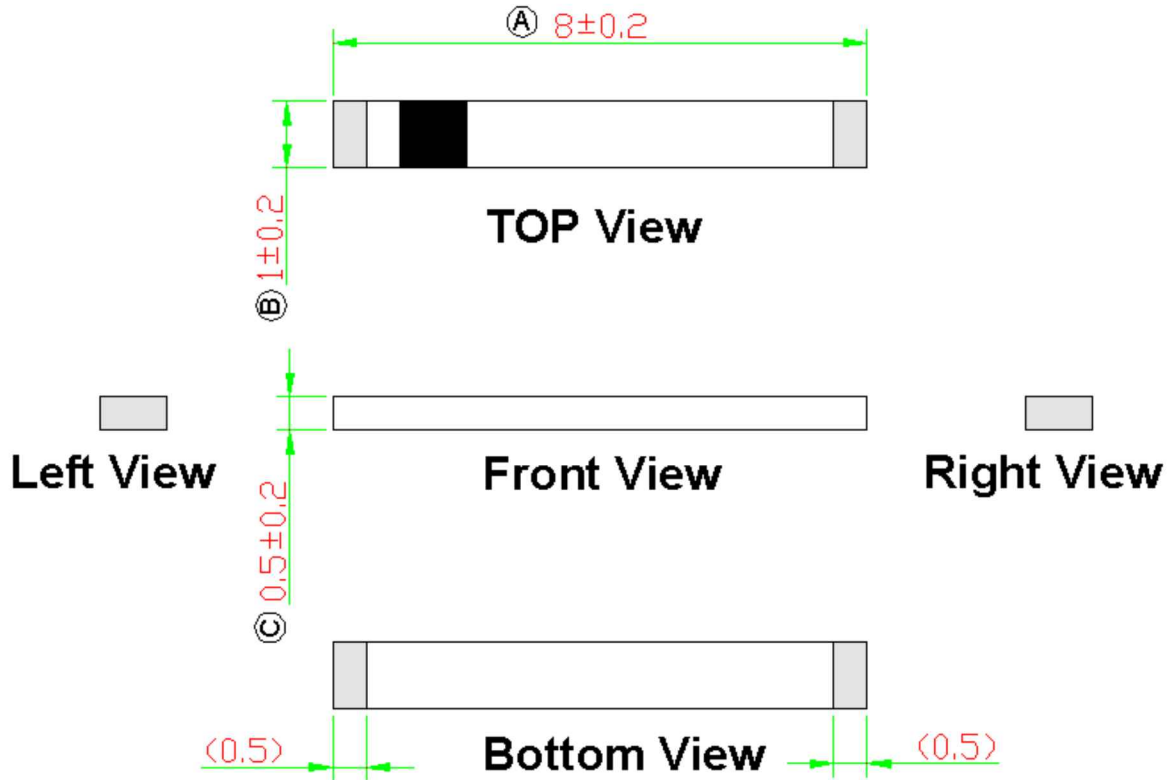

© Unictron Technologies Corp.  
All specifications subject to change without notice.

#### NOTE:

1. All materials are RoHS 2.0 compliant.
2. "A~C" Critical Dimensions.
3. "( )" Reference Dimensions.

#### b) PIN Definition



PIN	1	2
Soldering Pad	Signal Input	NC



c) Test Board with Antenna

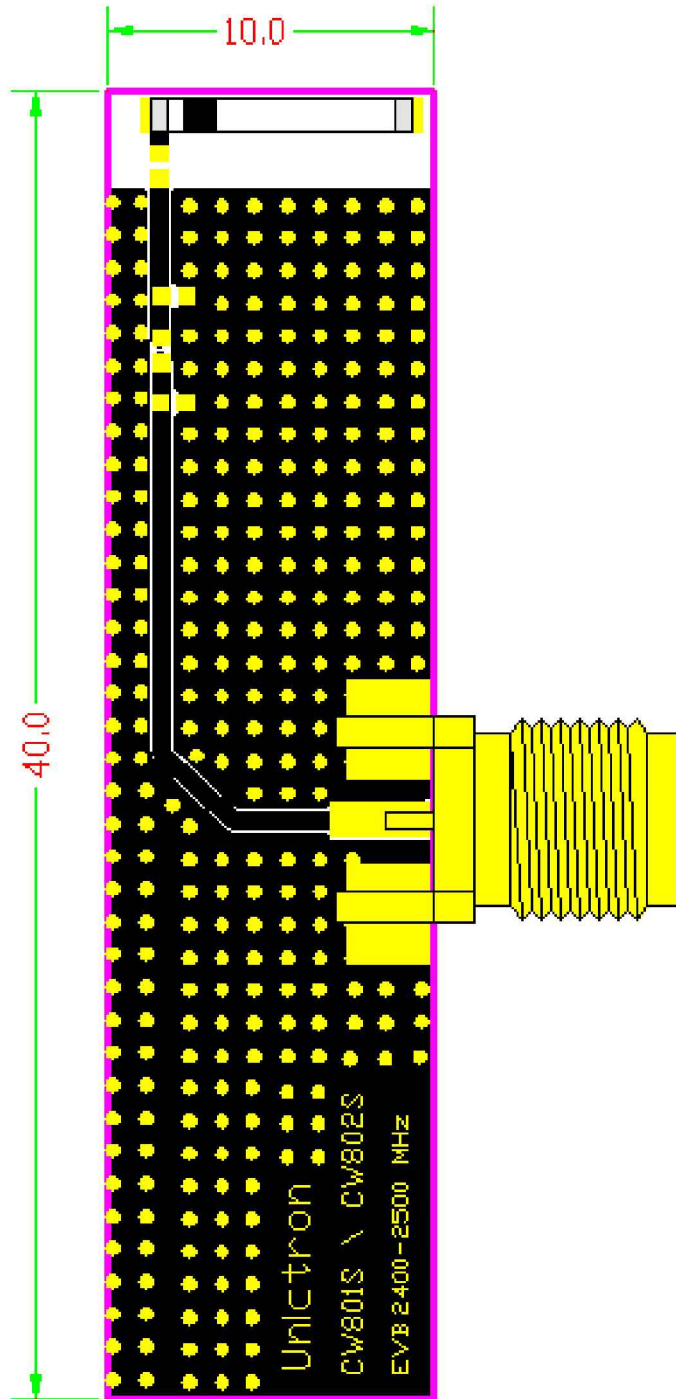

© Unictron Technologies Corp.  
All specifications subject to change without notice.



## IV. Properties:

### a) Return loss (dB)

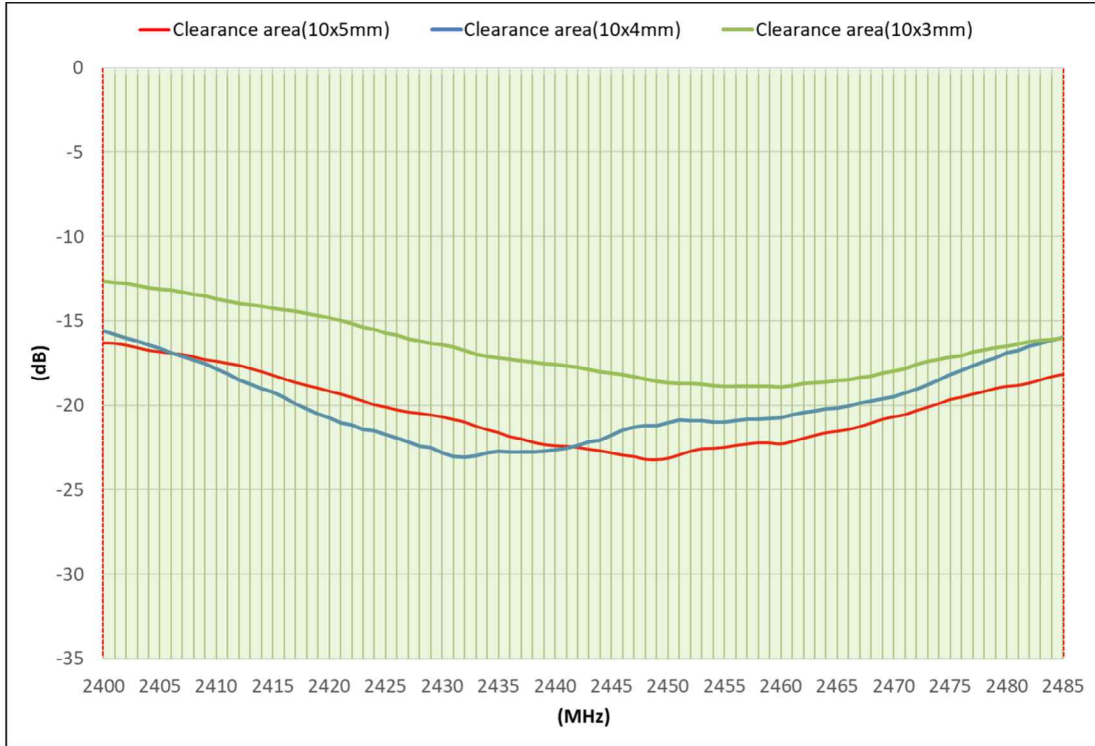

© Unictron Technologies Corp.  
All specifications subject to change without notice.

### b) Efficiency (%)

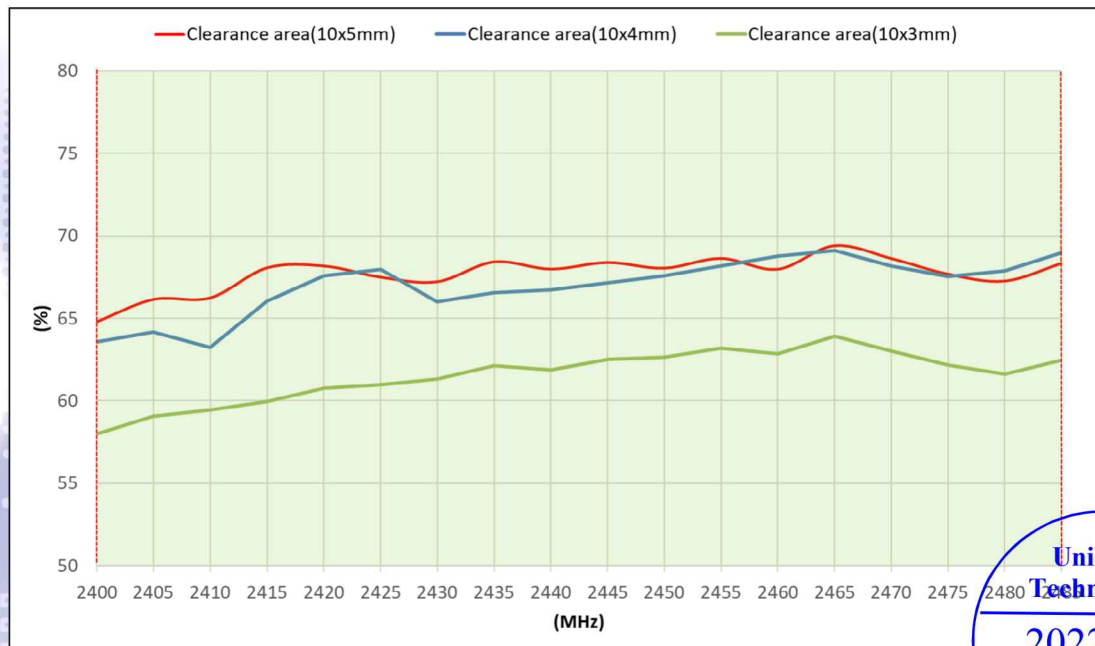

**Unictron Technologies**  
 2022/11/8  
 Document Control Center

**c) Average Gain (dB)**

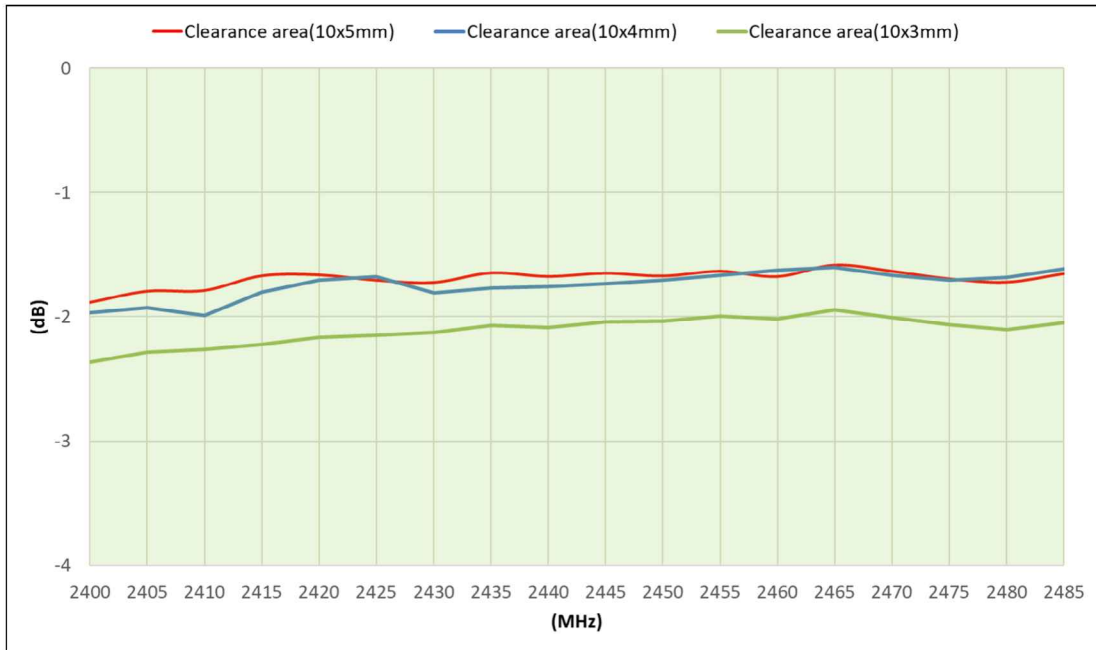

© Unictron Technologies Corp.  
All specifications subject to change without notice.

**d) Peak Gain (dBi)**

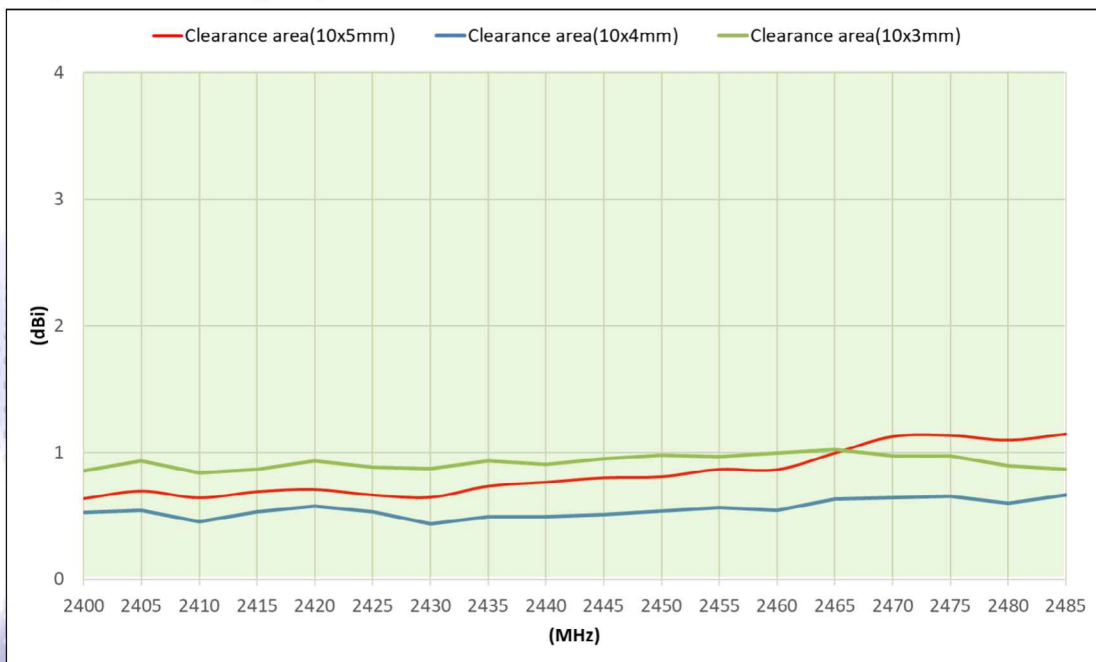



## V. Antenna Radiation Pattern Measurement:

The antenna radiation patterns are measured in Unictron's 3D Anechoic Chamber. The measurement setup is as show below.

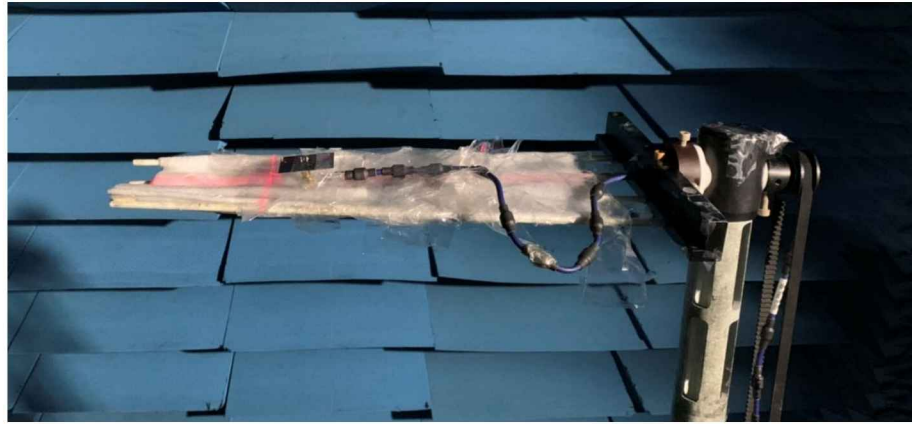

© Unictron Technologies Corp.  
All specifications subject to change without notice.

### 3D Radiation Gain Pattern

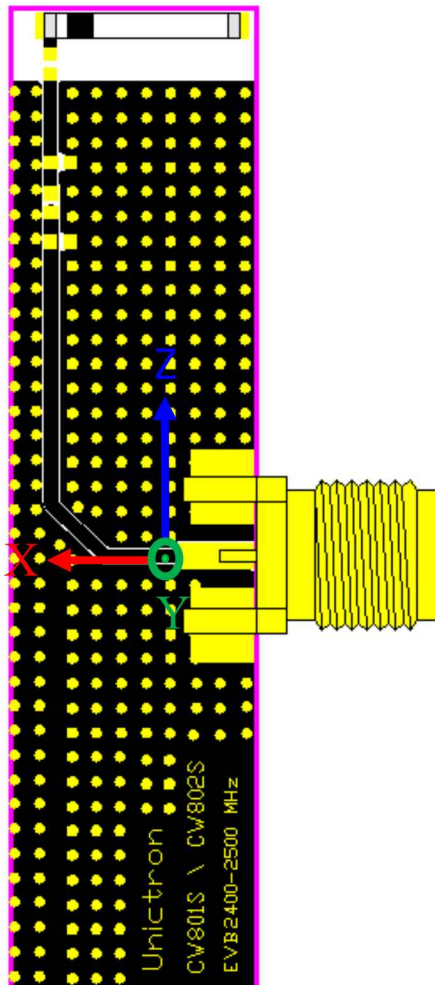

2445 MHz (unit: dBi)

a) Clearance area(10x5mm)

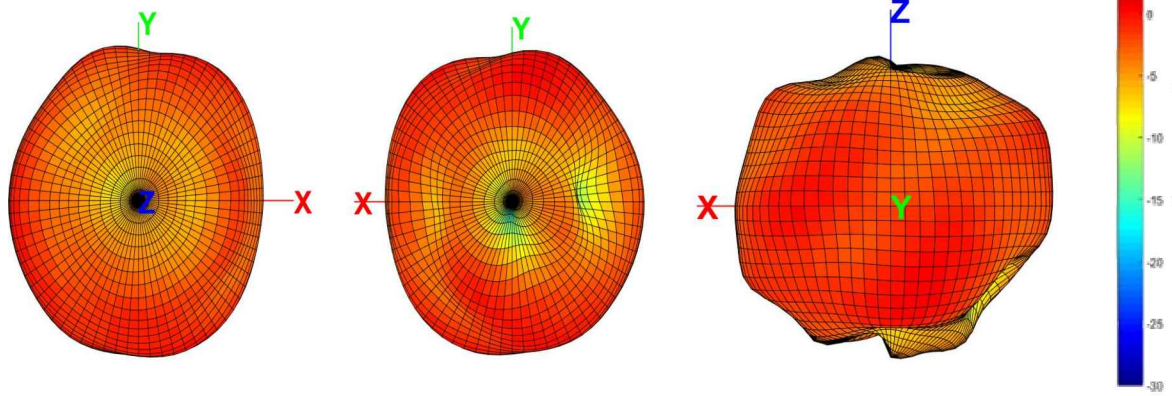

b) Clearance area(10x4mm)

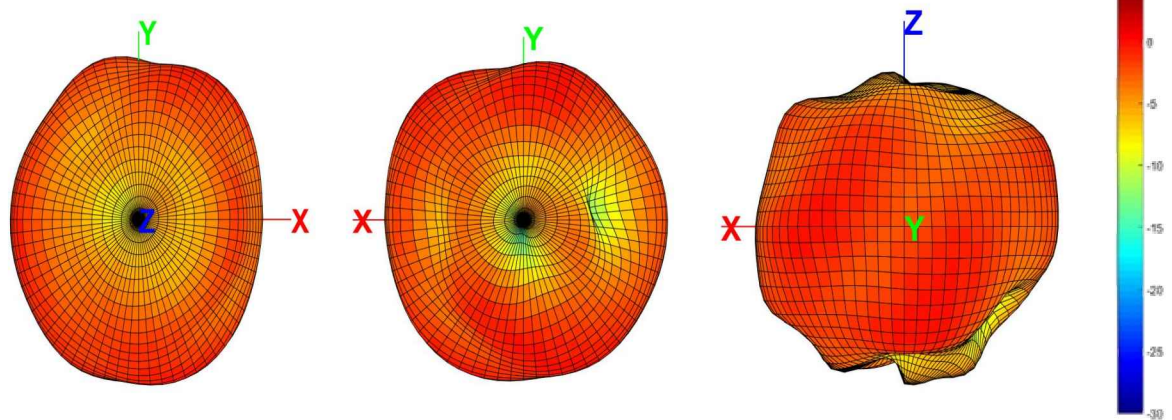

c) Clearance area(10x3mm)

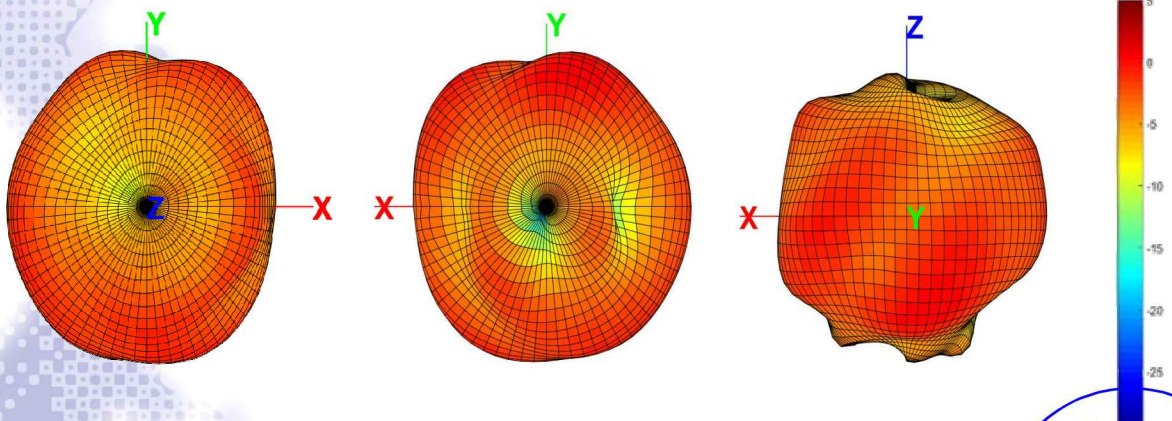

Unictron  
Technologies  
2022/11/8  
Document  
Control Center

## VI. Frequency tuning:

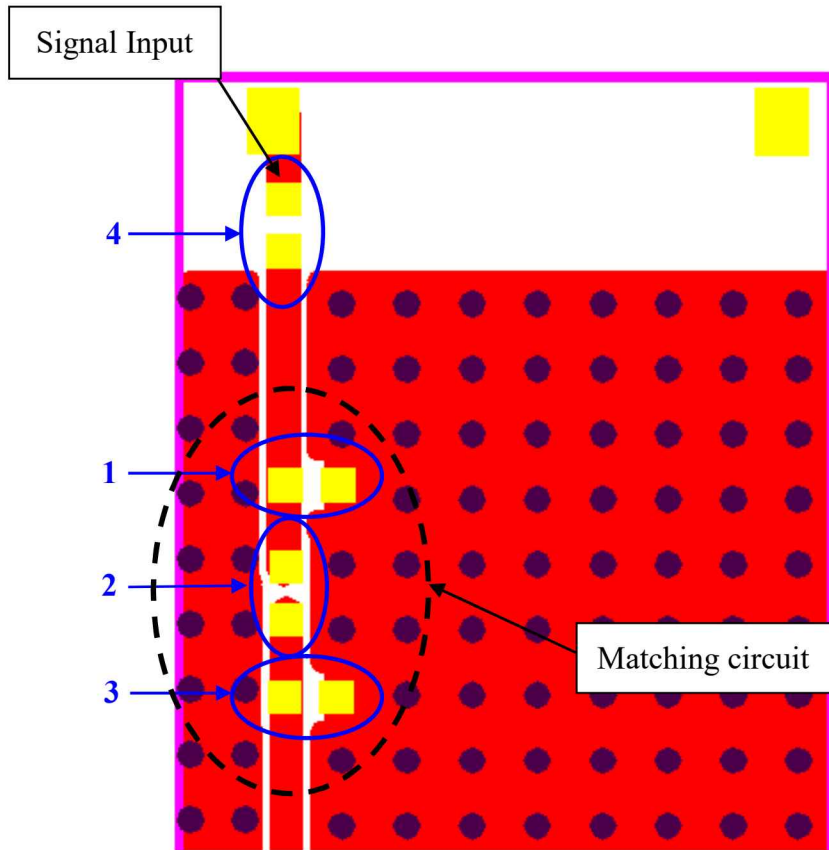

© Unictron Technologies Corp.  
All specifications subject to change without notice.

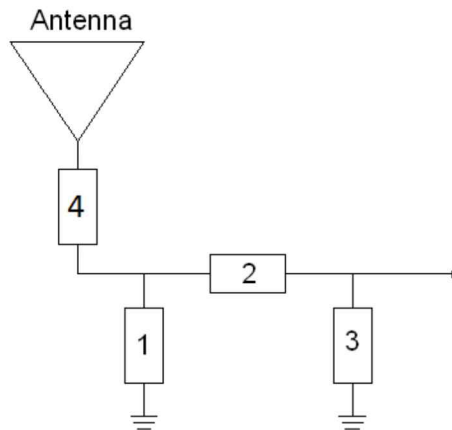

Clearance area(10x5mm) System Matching Circuit Component			
Location	Description	Vendor	Tolerance
1	N/C	-	-
2	0Ω (0402)	MURATA	±5%
3	0.4pF (0402)	MURATA	±0.1 pF
4	6.8nH (0402)	MURATA	±0.1 nH
Fine tuning element			

Unictron  
Technologies

2022/11/8

Document  
Control Center

<b>Clearance area(10x4mm) System Matching Circuit Component</b>			
Location	Description	Vendor	Tolerance
1	2.7nH (0402)	MURATA	±0.1 nH
2	1nH (0402)	MURATA	±0.1 nH
3	N/C	-	-
4 Fine tuning element	3.9nH (0402)	MURATA	±0.1 nH

<b>Clearance area(10x3mm) System Matching Circuit Component</b>			
Location	Description	Vendor	Tolerance
1	N/C	-	-
2	0Ω (0402)	MURATA	±5%
3	0.9pF (0402)	MURATA	±0.1 pF
4 Fine tuning element	5.6nH (0402)	MURATA	±0.1 nH

© Unictron Technologies Corp.  
All specifications subject to change without notice.



## VII. Soldering conditions:

### Typical Soldering Profile for Lead-free Process

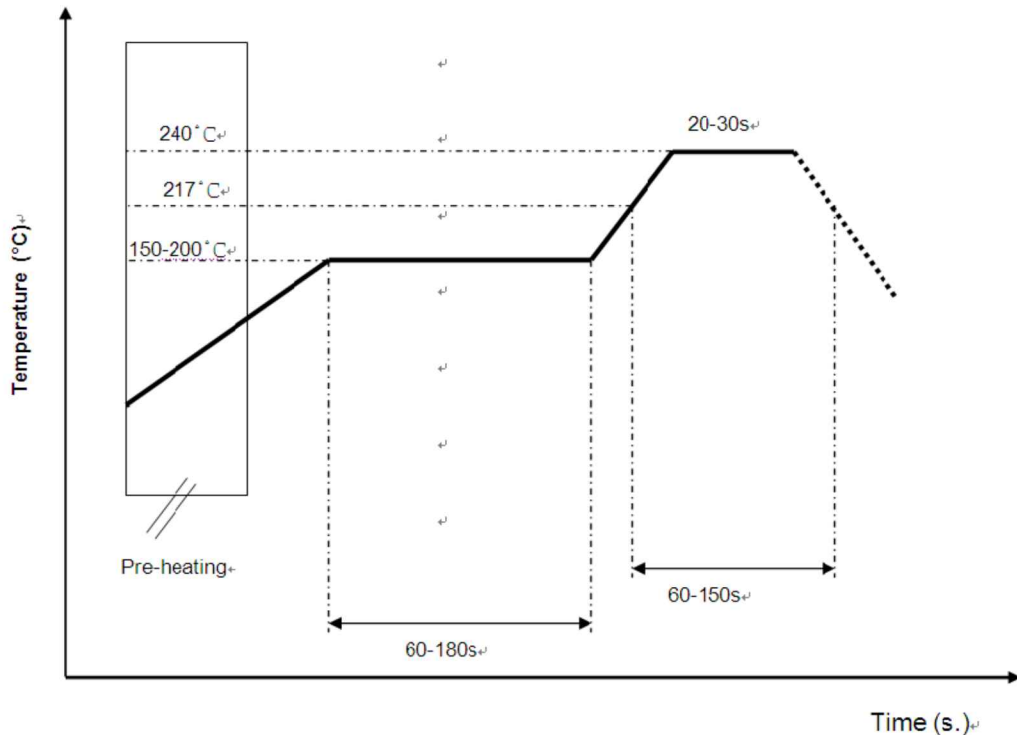

© Unictron Technologies Corp.  
All specifications subject to change without notice.

\*Recommended solder paste alloy: SAC305 (Sn96.5 /Ag3 /Cu0.5) Lead Free solder paste.

## VIII. Reminders for use of Unictron's ceramic chip antennas:

- a) This chip antenna is made of ceramic materials which is relatively more rigid and brittle compared to circuit board materials. Furthermore, the length of this antenna is quite long. Bending of circuit board at the locations where chip antenna is mounted may cause the cracking of solder joints or antenna itself.
- b) Punching/cutting of the break-off tab of PCB panel may cause severe bending of the circuit board which may result in cracking of solder joints or chip antenna itself. Therefore break-off tab shall be located away from the installation site of chip antenna.
- c) Be cautious when ultrasonic welding process needs to be used near the locations where chip antennas are installed. Strong ultrasonic vibration may cause the cracking of chip antenna solder joints.



## IX. Operating & Storage conditions:

- a) Operating**
  - (1) Maximum Input Power: 2 W
  - (2) Operating Temperature: -40°C to 85°C
  - (3) Relative Humidity: 10% to 70%
  
- b) Storage (sealed)**
  - (1) Storage Temperature: -5°C to 40°C
  - (2) Relative Humidity: 20% to 70%
  - (3) Shelf Life: 1 year
  
- c) Storage (After mounted on customer's PCB with SMT process)**
  - (1) Storage Temperature: -40°C to 85°C
  - (2) Relative Humidity: 10% to 70%

© Unictron Technologies Corp.  
All specifications subject to change without notice.

## X. Notice

- (1) Installation Guide:  
Please refer to Unictron's application note "General guidelines for the installation of Unictron's chip antennas" for further information.
- (2) All specifications are subject to change without notice.



## XI. Packing

- (1) Unit Weight:  $0.03 \pm 0.005$ (g) /pcs
- (2) Quantity/Reel: 5000 pcs/Reel
- (3) Plastic tape: Black Conductive Polystyrene.

### a. Tape Drawing (unit: mm)

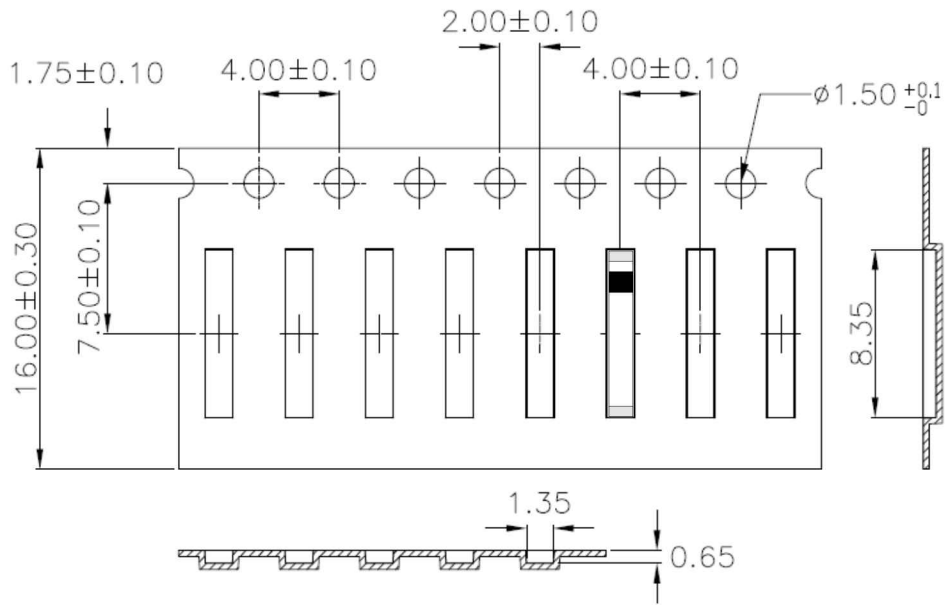

### b. Reel Drawing (unit: mm)

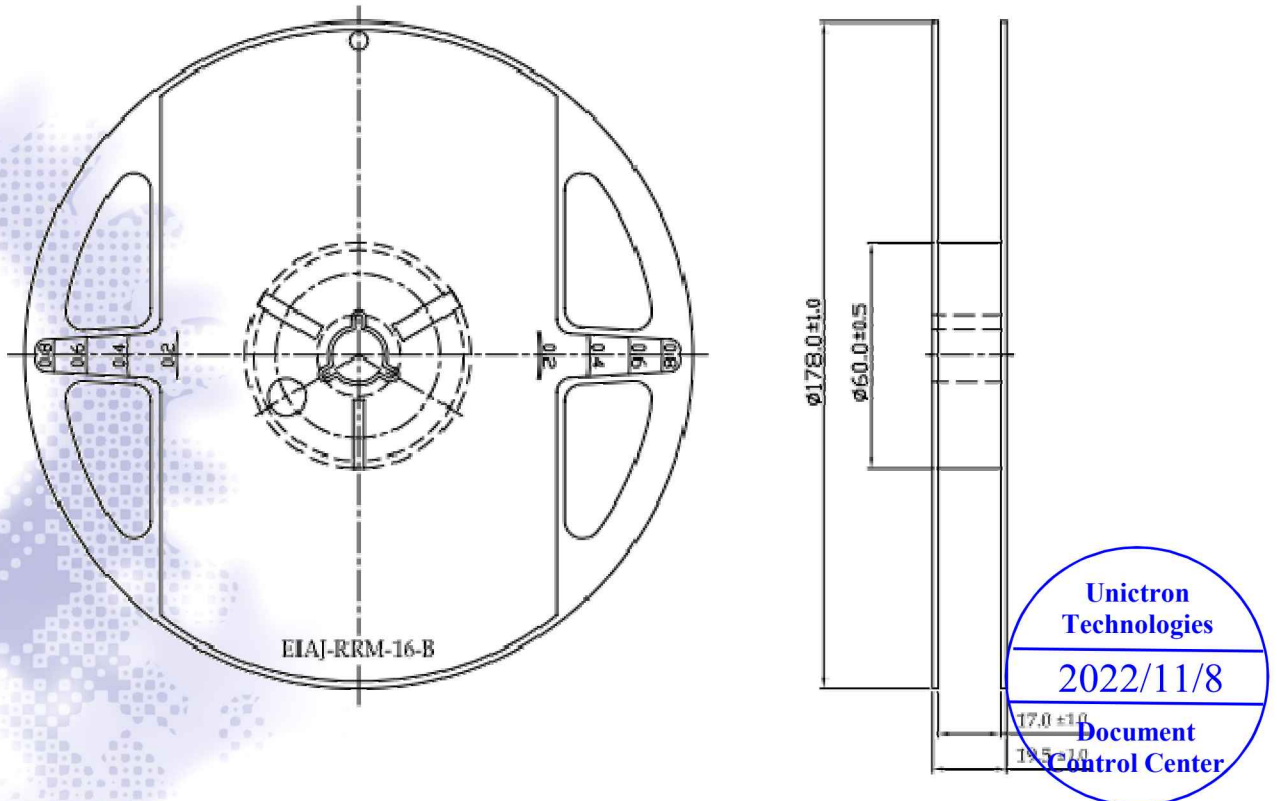

© Unictron Technologies Corp.  
All specifications subject to change without notice.

c. Drawing of small size carton in developed view

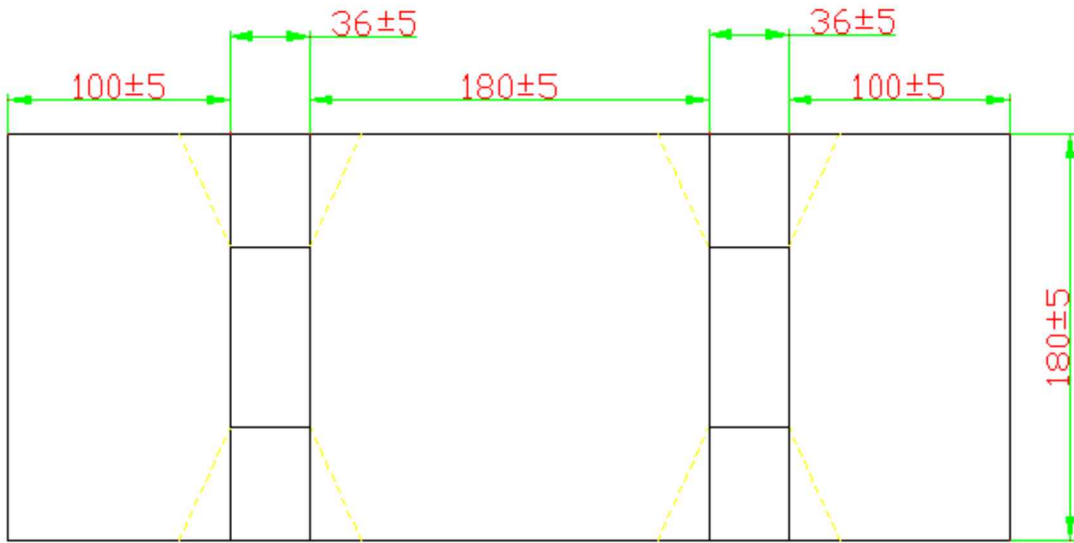

© Unictron Technologies Corp.  
All specifications subject to change without notice.

d. Drawing of middle size carton in developed view

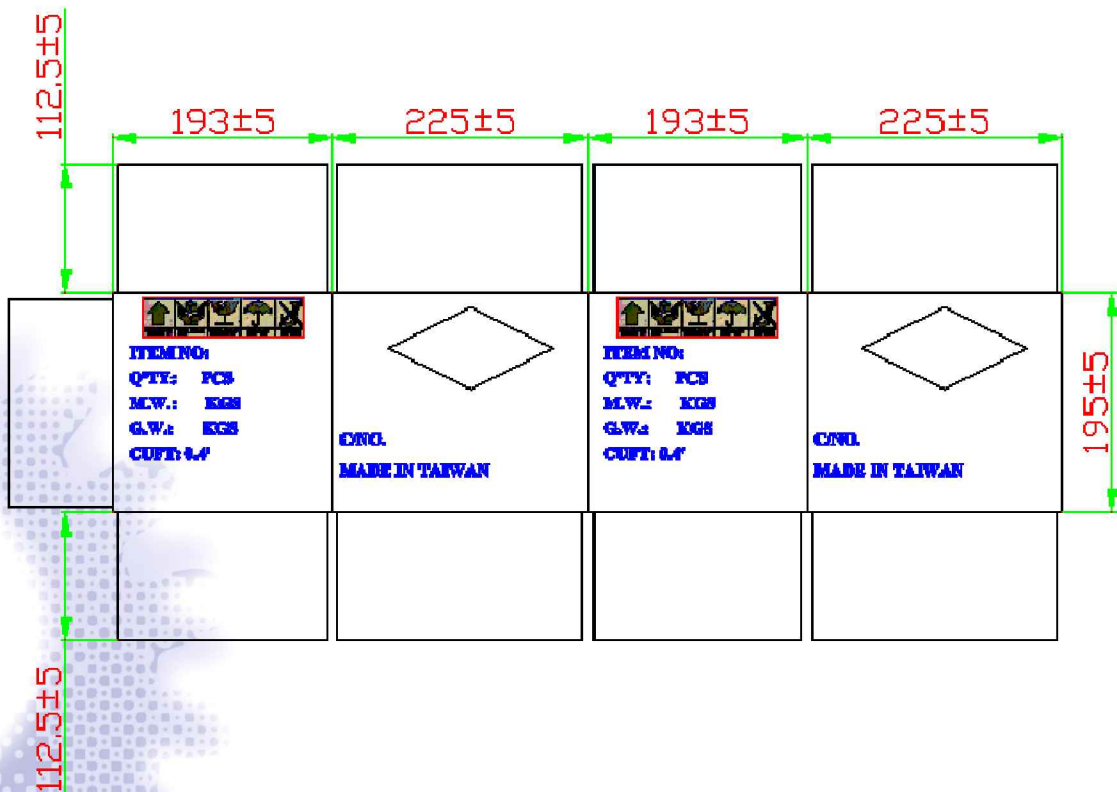



e. Drawing of large size carton in developed view

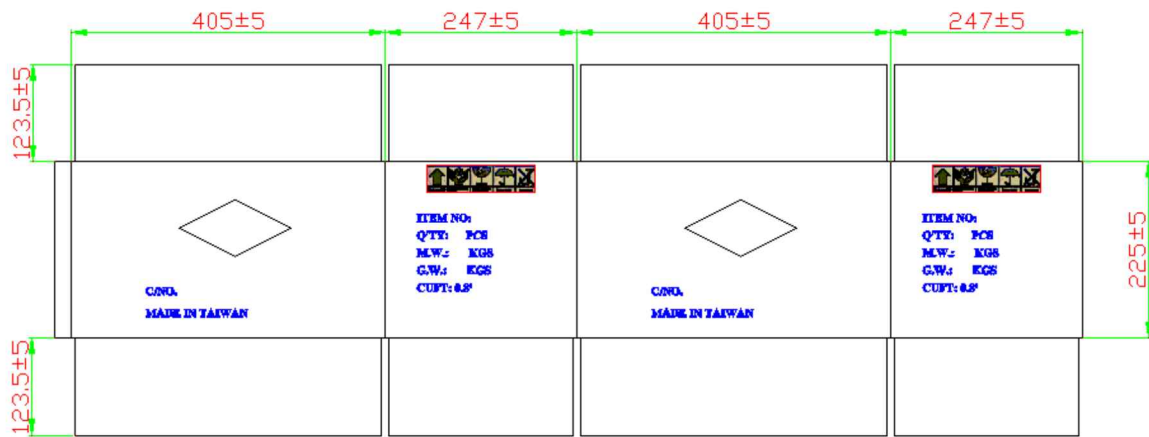

© Unictron Technologies Corp.  
All specifications subject to change without notice.

f. Process of packing

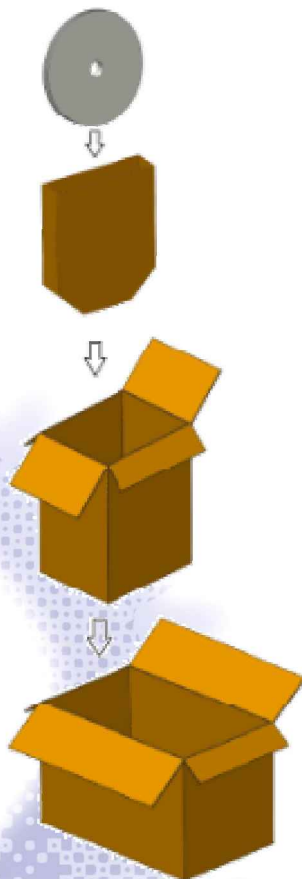

1 reel includes 5,000pcs(max.) chip antennas

1 small size carton includes 1pcs(max.) reels

1 middle size carton includes 5pcs(max.) small cartons

1 large size carton includes 2pcs(max.) middle cartons

