

1T 8051

8-bit Microcontroller

NuMaker-MS51PC

User Manual

NuMicro[®] 8051 Series

The information described in this document is the exclusive intellectual property of Nuvoton Technology Corporation and shall not be reproduced without permission from Nuvoton.

Nuvoton is providing this document only for reference purposes of NuMicro microcontroller based system design. Nuvoton assumes no responsibility for errors or omissions.

All data and specifications are subject to change without notice.

For additional information or questions, please contact: Nuvoton Technology Corporation.

www.nuvoton.com

Table of Contents

1 OVERVIEW 6

 1.1 NuMaker-MS51PC Features 7

2 NUMAKER-MS51PC OVERVIEW 8

 2.1 Front View 8

 2.2 Rear View 9

 2.3 Arduino UNO Compatible Extension Connectors..... 10

 2.4 Pin Assignment for Extension Connectors 12

 2.5 System Configuration..... 15

 2.5.1 VIN Power Source 15

 2.5.2 5 V Power Sources 15

 2.5.3 3.3 V Power Sources 15

 2.5.4 1.8V Power Sources 15

 2.5.5 Power Connectors 16

 2.5.6 USB Connectors 16

 2.5.7 Power Switches 16

 2.5.8 Power Supply Models 16

 2.5.9 Ammeter Connector 20

 2.5.10 Extension Connectors 20

 2.5.11 Push-Buttons 20

 2.5.12 LEDs 20

 2.6 Nu-Link2-Me 22

 2.7 PCB Placement 23

3 QUICK START 24

 3.1 Toolchains Supporting 24

 3.2 Nuvoton Nu-Link Driver Installation 25

 3.3 BSP Firmware Download 27

 3.4 Hardware Setup 28

 3.5 Find the Example Project 30

 3.6 Execute the Project under Toolchains 31

 3.6.1 Keil PK51 31

 3.6.2 IAR EW8051 33

4 NUMAKER-MS51PC SCHEMATICS 36

 4.1 Nu-Link2-Me 36

 4.2 MS51 Platform 37

 4.3 Extension Connector 38

5 REVISION HISTORY39

List of Figures

Figure 1.1-1 NuMaker-MS51PC Board..... 6

Figure 2.1-1 Front View of NuMaker-MS51PC 8

Figure 2.2-1 Rear View of NuMaker-MS51PC 9

Figure 2.3-1 Arduino UNO Compatible Extension Connectors..... 10

Figure 2.4-1 MS51PC0AE Extension Connectors 12

Figure 2.5-1 External Power Supply Sources on Nu-Link2-Me 17

Figure 2.5-2 External Power Supply Sources on MS51 Platform 18

Figure 2.5-3 Separate the Nu-Link2-Me from NuMaker-MS51PC..... 19

Figure 2.5-4 Wiring between Ammeter Connector and Ammeter..... 20

Figure 2.7-1 Front Placement 23

Figure 2.7-2 Rear Placement..... 23

Figure 3.2-1 Nu-Link USB Driver Installation Setup..... 25

Figure 3.2-2 Nu-Link USB Driver Installation 26

Figure 3.4-1 Open VCOM Function 28

Figure 3.4-2 ICE USB Connector..... 28

Figure 3.4-3 Device Manger..... 29

Figure 3.4-4 PuTTY Session Setting 29

Figure 3-5 Template Project Folder Path..... 30

Figure 3.6-1 Project File Migrate to Version 5 Format..... 31

Figure 3.6-2 Debugger Setting in Options Window..... 31

Figure 3.6-3 Programming Setting in Options Window..... 32

Figure 3.6-4 Compile and Download the Project 32

Figure 3.6-5 Keil MDK Debug Mode 33

Figure 3.6-6 Debug Message on Serial Port Terminal Windows..... 33

Figure 3.6-7 IAR EW8051 Window 34

Figure 3.6-8 Compile and Download the Project 34

Figure 3.6-9 IAR EW8051 Debug Mode 35

Figure 3.6-10 Debug Message on Serial Port Terminal Windows..... 35

Figure 4.1-1 Nu-Link2-Me Circuit..... 36

Figure 4.2-1 MS51 Platform Circuit..... 37

Figure 4.3-1 Extension Connectors Circuit 38

List of Tables

Table 2.3-1 Arduino UNO Extension Connectors and MS51PC0AE Mapping GPIO List 11

Table 2.4-1 MS51PC0AE Full-pin Extension Connectors and GPIO Function List 13

Table 2.5-1 Vin Power Source 15

Table 2.5-2 5V Power Sources 15

Table 2.5-3 3.3 V Power Sources 15

Table 2.5-4 1.8V Power Sources 16

Table 2.5-5 Power Connectors 16

Table 2.5-6 USB Connectors 16

Table 2.5-7 Power Switches 16

Table 2.5-8 Supply External Power through Nu-Link2-Me 17

Table 2.5-9 Supply External Power for MS51 platform 19

Table 2.5-10 Ammeter Connector 20

Table 2.5-11 Extension Connectors 20

Table 2.5-12 Push-Buttons 20

Table 2.5-13 LEDs 21

Table 2.6-1 VCOM Function of Nu-Link2-Me 22

1 OVERVIEW

This user manual is aimed to give users a fast introduction to the use of NuMaker-MS51PC board.

The NuMaker-MS51PC consists of two parts, a MS51 platform and an on-board Nu-Link2-Me debugger and programmer. The NuMaker-MS51PC allows users to quickly develop and easily program and debug application.

The NuMaker-MS51PC offers MS51PC0AE full pins extension connectors, Arduino UNO compatible extension connectors and diversified power supply option. It is an easy-to-develop platform for user to expand the functionality and build the applications. The NuMaker-MS51PC also provides an ammeter connector, allows user to monitor the microcontroller's power consumption during development.

The Nu-Link2-Me is a debugger and programmer that support on-line programming and debugging through OCD interface. The on-board 16 Mbit SPI Flash allows it able to off-line programming the target microcontroller. Nu-Link2-Me provides virtual COM port (VCOM) function to print out messages on PC. Nu-Link2-Me can be separated from NuMaker-MS51PC, allowing user to use as a mass production programming tool.

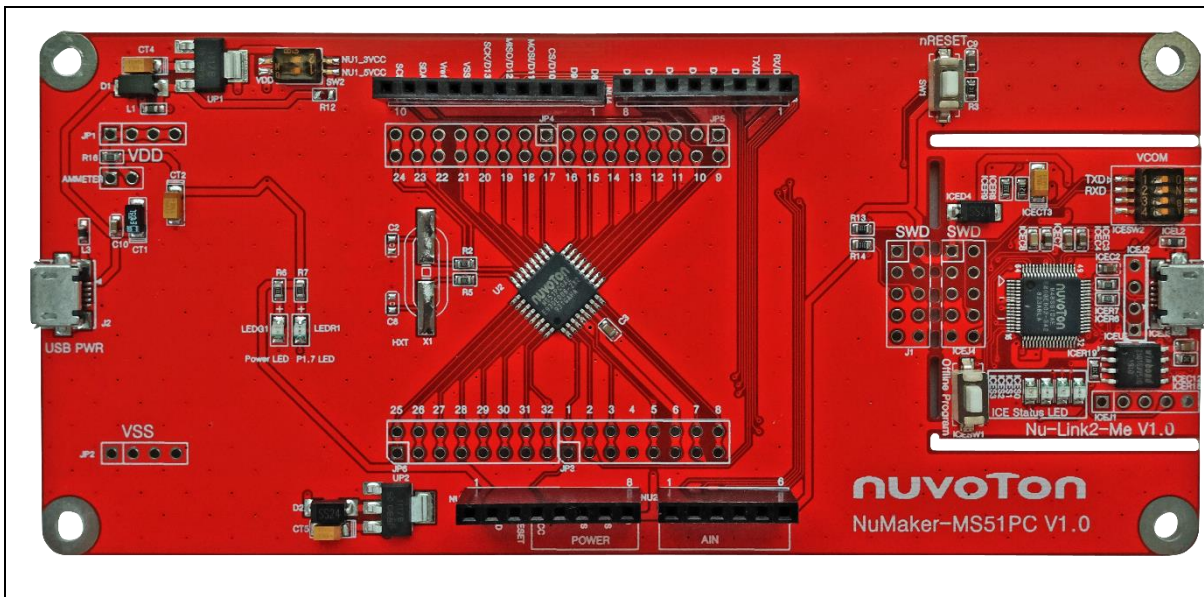

Figure 1.1-1 NuMaker-MS51PC Board

1.1 NuMaker-MS51PC Features

- NuMicro® MS51PC0AE used as main microcontroller with function downward compatible with:
 - ◆ MS51EC0AE
 - ◆ MS51FC0AE
 - ◆ MS51TC0AE
 - ◆ ML51XC0AE
- MS51PC0AE full pins extension connectors
- Arduino UNO compatible extension connectors
- Ammeter connector for measuring the microcontroller's power consumption
- Fixable board power supply:
 - ◆ External V_{DD} power connector
 - ◆ Arduino UNO compatible extension connector V_{in}
 - ◆ USB power connector on MS51 platform
 - ◆ ICE USB connector on Nu-Link2-Me
- On-board Nu-Link2-Me debugger and programmer:
 - ◆ Debug through OCD interface
 - ◆ On-line/off-line programming
 - ◆ Virtual COM port function

2 NUMAKER-MS51PC OVERVIEW

2.1 Front View

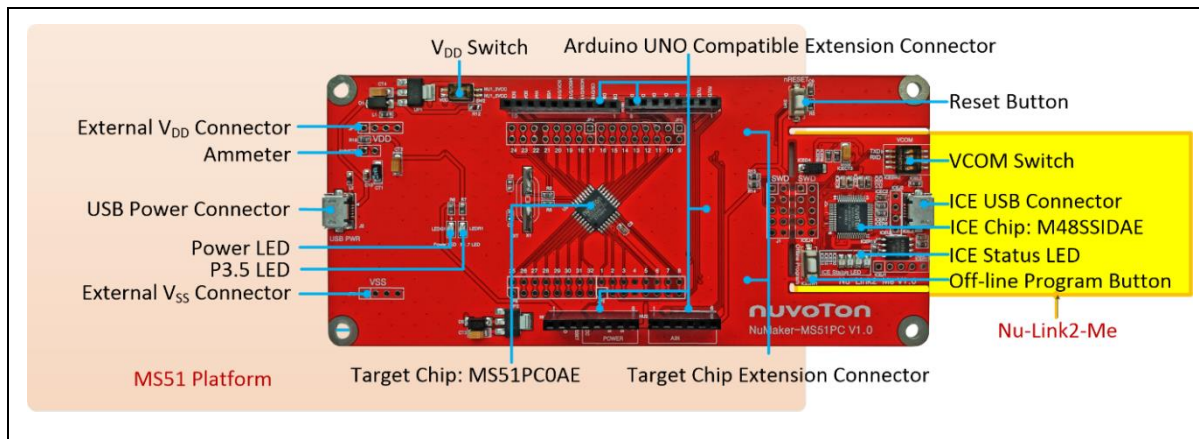

Figure 2.1-1 Front View of NuMaker-MS51PC

Figure 2.1-1 shows the main components and connectors from the front side of NuMaker-MS51PC. The following lists components and connectors from the front view:

- Target Chip: MS51PC0AE (U2)
- USB Power Connector (J2)
- Arduino UNO Compatible Extension Connectors (NU1, NU2, NU3, NU4)
- MS51 Extension Connectors (JP3, JP4, JP5 and JP6)
- External V_{DD} Power Connector(JP1)
- External V_{SS} Power Connector(JP2)
- V_{DD} Switch(SW2)
- Ammeter Connector(AMMETER)
- Reset Button(SW1)
- Power LED and P3.5 LED (LEDG1 and LEDR1)
- Nu-Link2-Me
 - ◆ VCOM Switch
 - ◆ ICE Chip: M48SSIDAE(ICEU2)
 - ◆ ICE USB Connector(ICEJ3)
 - ◆ ICE Status LED (ICES0,ICES1, ICES2, ICES3)
 - ◆ Off-line Program Button(ICESW1)

2.2 Rear View

Figure 2.2-1 shows the main components and connectors from the rear side of NuMaker-MS51PC.

The following lists components and connectors from the rear view:

- Nu-Link2-Me
 - ◆ MCUVCC Power Switch (ICEJPR1)
 - ◆ ICEVCC Power Switch (ICEJPR2)

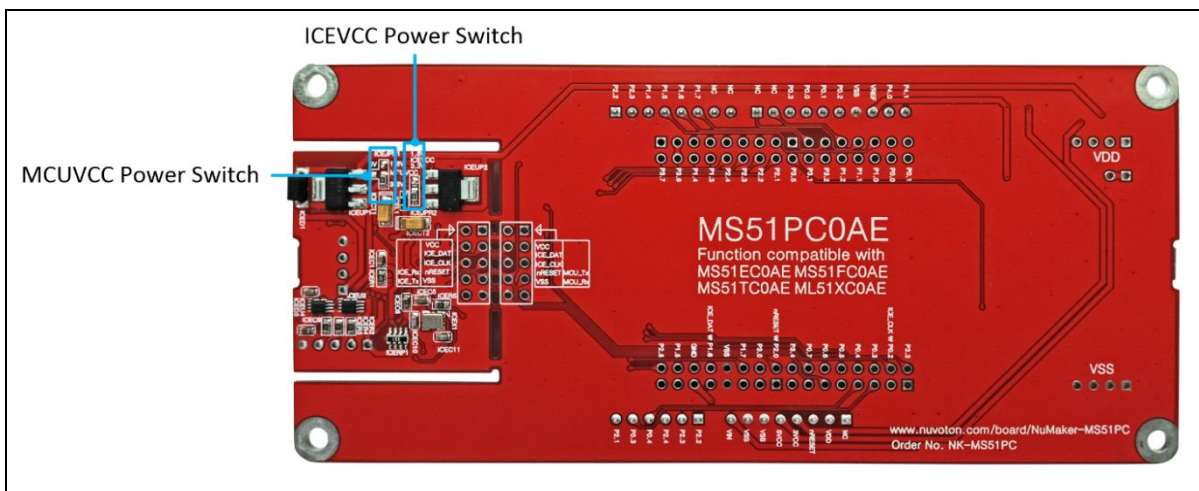

Figure 2.2-1 Rear View of NuMaker-MS51PC

2.3 Arduino UNO Compatible Extension Connectors

Figure 2.3-1 shows the Arduino UNO compatible extension connectors.

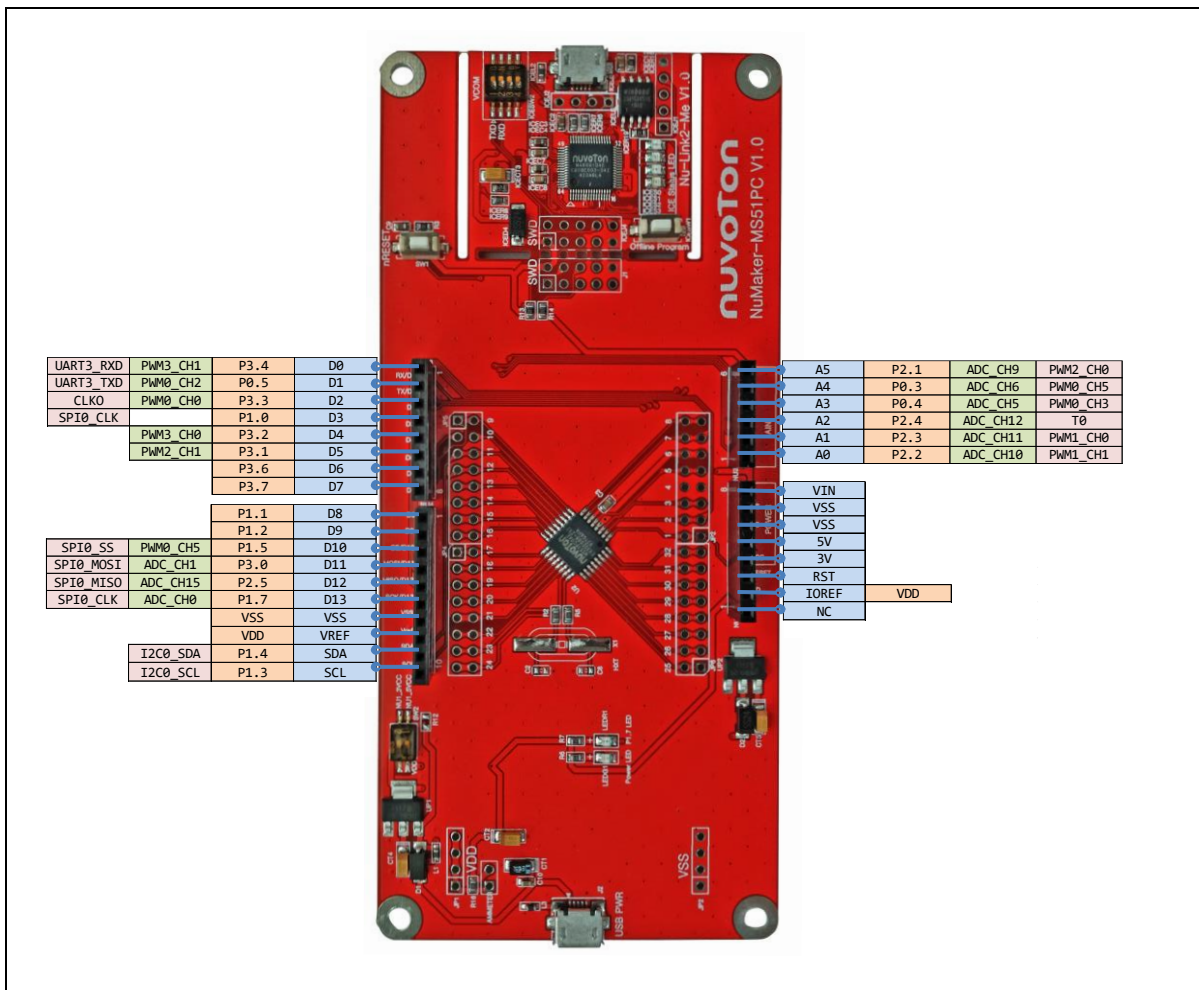

Figure 2.3-1 Arduino UNO Compatible Extension Connectors

Header		NuMaker-MS51PC		Header		NuMaker-MS51PC	
		Compatible to Arduino UNO	GPIO Pin of MS51			Compatible to Arduino UNO	GPIO Pin of MS51
N U 3	NU3.1	D0	P3.4	N U 2	NU2.6	A5	P2.1
	NU3.2	D1	P0.5		NU2.5	A4	P0.3
	NU3.3	D2	P3.3		NU2.4	A3	P0.4
	NU3.4	D3	P1.0		NU2.3	A2	P2.4
	NU3.5	D4	P3.2		NU2.2	A1	P2.3
	NU3.6	D5	P3.1		NU2.1	A0	P2.2
	NU3.7	D6	P3.6	N U 1	NU1.8	VIN	-
	NU3.8	D7	P3.7		NU1.7	VSS	
N U 4	NU4.1	D8	P1.1		NU1.6	VSS	
	NU4.2	D9	P1.2		NU1.5	5V	
	NU4.3	D10	P1.5		NU1.4	3V	
	NU4.4	D11	P3.0		NU1.3	RST	nRESET
	NU4.5	D12	P2.5		NU1.2	IOREF	VDD
	NU4.6	D13	P1.7	NU1.1	NC	-	
	NU4.7	VSS	VSS				
	NU4.8	VREF	VDD				
	NU4.9	I2C_SDA	P1.4				
	NU4.10	I2C_SCL	P1.3				

Table 2.3-1 Arduino UNO Extension Connectors and MS51PC0AE Mapping GPIO List

2.4 Pin Assignment for Extension Connectors

The NuMaker-MS51PC provides the MS51PC0AE target chip onboard and full pins extension connectors (JP3, JP4, JP5 and JP6). The Figure 2.4-1 shows the MS51PC0AE extension connectors.

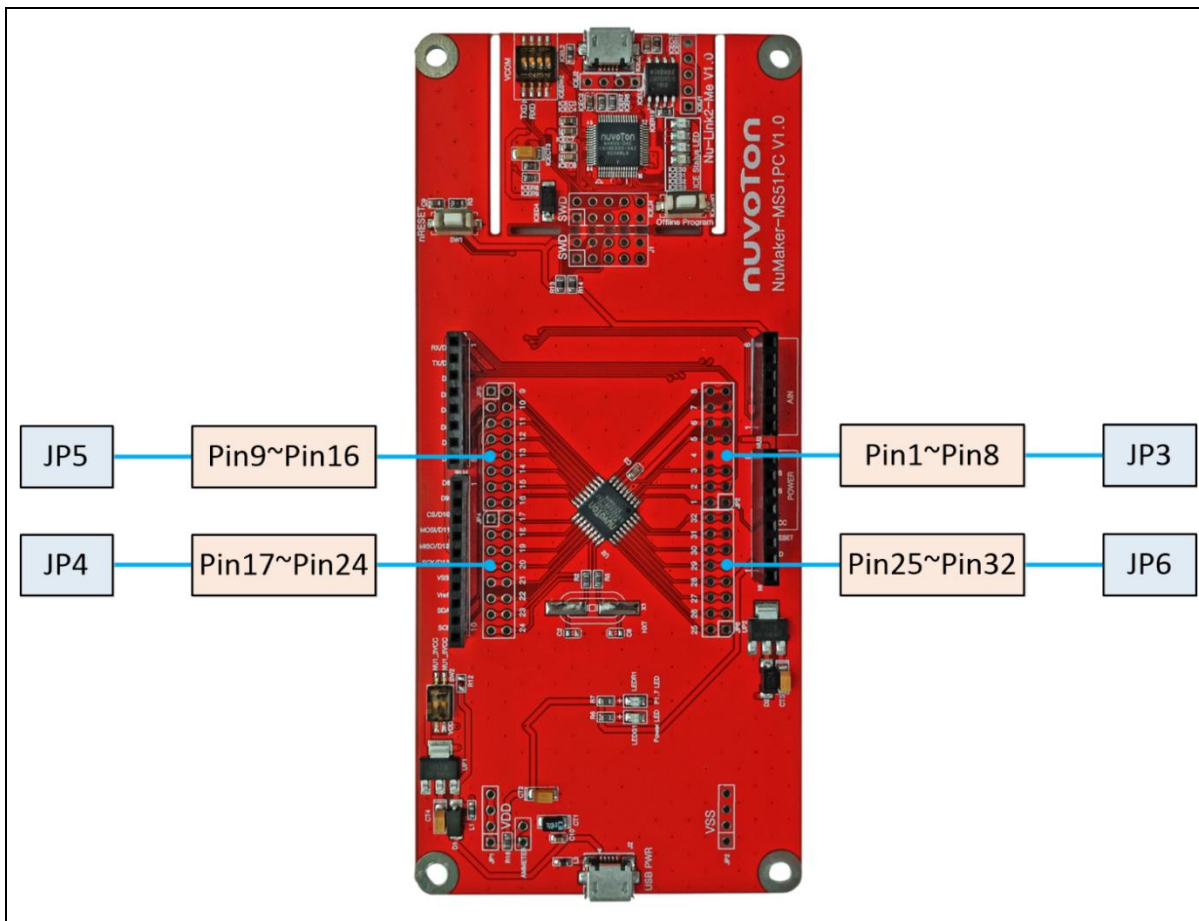

Figure 2.4-1 MS51PC0AE Extension Connectors

Header			MS51PC0AE	
			Pin No.	Function
JP3	JP3.1	JP3.2	1	P2.0/RESET
	JP3.3	JP3.4	2	P3.0/OSCIN/INT0/UART2_TX/SPI0_MOSI/ADC_CH1
	JP3.5	JP3.6	3	P1.7/INT1/UART2_RX/SPI0_CLK/ADC_CH0
	JP3.7	JP3.8	4	VSS
	JP3.9	JP3.10	5	P1.6/ICE_DAT/ICP_DAT/UART1_TX /I2C0_SDA
	JP3.11	JP3.12	6	GND
	JP3.13	JP3.14	7	P1.5/UART3_TX/SPI0_SS/ IC7/PWM3_CH1/PWM0_CH5
	JP3.15	JP3.16	8	P2.5/UART3_RX/SPI0_MISO/ADC_CH15
JP5	JP5.1	JP5.2	9	P3.7/UART1_RX
	JP5.3	JP5.4	10	P3.6/UART1_TX
	JP5.5	JP5.6	11	P1.4/PWM0_CH1/I2C0_SDA/PWM0_BRAKE/ADC_CH14/ PWM1_CH1
	JP5.7	JP5.8	12	P1.3/STADC/I2C0_SCL/ADC_CH13
	JP5.9	JP5.10	13	P2.4/T0 /ADC_CH12
	JP5.11	JP5.12	14	P2.3/UART4_TX/PWM1_CH0/ADC_CH11
	JP5.13	JP5.14	15	P2.2/UART4_RX/PWM1_CH1/ADC_CH10
	JP5.15	JP5.16	16	P2.1/PWM2_CH0/ADC_CH9
JP4	JP4.1	JP4.2	17	P3.5/SPI0_SS
	JP4.3	JP4.4	18	P3.1/PWM2_CH1
	JP4.5	JP4.6	19	P3.2/PWM3_CH0
	JP4.7	JP4.8	20	P1.2/PWM0_CH0 / IC0 / UART3_TXD / PWM1_CH0
	JP4.9	JP4.10	21	P1.1/ADC_CH7 / CLKO / IC1 / PWM0_CH1 / UART3_RXD / PWM1_CH1
	JP4.11	JP4.12	22	P1.0/PWM0_CH2 / SPI0_CLK / IC2 / UART1_TXD / PWM2_CH0
	JP4.13	JP4.14	23	P0.0/PWM0_CH3 / SPI0_MOSI / IC3 / UART1_RXD / T1 / HXTIN / PWM2_CH1
	JP4.15	JP4.16	24	P0.1/PWM0_CH4 / SPI0_MISO / IC4 / HXTOUT / PWM3_CH0
JP6	JP6.1	JP6.2	25	P3.3/ICE_CLK / I2C0_SCL / UART1_RXD
	JP6.3	JP6.4	26	P0.2/ICE_CLK / I2C0_SCL / UART1_RXD
	JP6.5	JP6.6	27	P0.3/ADC_CH6 / IC5 / PWM0_CH5 / UART2_TXD / PWM3_CH1
	JP6.7	JP6.8	28	P0.4/ADC_CH5 / IC3 / PWM0_CH3 / STADC / UART2_RXD / PWM2_CH1
	JP6.9	JP6.10	29	P0.5/ADC_CH4 / PWM0_CH2 / PWM2
	JP6.11	JP6.12	30	P0.6/ADC_CH3 / UART0_TX
	JP6.13	JP6.14	31	P0.7/ADC_CH2 / UART0_RX
	JP6.15	JP6.16	32	P3.4/PWM3_CH1 / UART3_RX

Table 2.4-1 MS51PC0AE Full-pin Extension Connectors and GPIO Function List

2.5 System Configuration

2.5.1 VIN Power Source

Table 2.5-1 presents the Vin power source.

Connector	Net Name in Schematic	Comment
NU1 pin8	NU1_VIN	Board external power source, with voltage range from 7 V to 12 V. The voltage regulator UP2 converts the NU1 pin8 input voltage to 5 V and supplies it to NuMaker-MS51PC.

Table 2.5-1 Vin Power Source

2.5.2 5 V Power Sources

Table 2.5-2 presents the 5 V power sources.

Connector	Net Name in Schematic	Comment
ICEJ3	USB_HS_VBUS	ICE USB connector supplies 5 V power from PC to MS51 platform and Nu-Link2-Me.
J2	USB_VBUS	USB connector on NuMaker-MS51PC supplies 5 V power from PC to MS51 platform and Nu-Link2-Me.
NU1 pin5	NU1_5VCC	ICEJ3, J2 or NU1 pin8 supplies 5 V power to NU1 pin5. NU1 pin5 supplies 5 V power to target chip or Arduino adapter board.

Table 2.5-2 5V Power Sources

2.5.3 3.3 V Power Sources

Table 2.5-3 presents the 3.3 V power sources.

Voltage Regulator	5V Source	Comment
ICEUP1	USB_HS_VBUS	ICEUP1 converts USB_HS_VBUS to 3.3 V and supplies 3.3V to MS51 platform or ICE chip.
UP1	USB_VBUS	UP1 converts USB_VBUS to 3.3 V and supplies 3.3 V to MS51 platform. Note: SW2.2(NU1 3VCC) should be switched to ON.
UP1	NU1_5VCC	UP1 converts NU1_5VCC to 3.3 V and supplies 3.3 V to MS51 platform. Note: SW2.2(NU1 3VCC) should be switched to ON.

Table 2.5-3 3.3 V Power Sources

2.5.4 1.8V Power Sources

Table 2.5-4 presents the 1.8 V power source.

Voltage Regular	5V Source	Comment
ICEUP2	USB_HS_VBUS	ICEUP2 converts USB_HS_VBUS to 1.8V and supplies 1.8V to MS51 platform or ICE chip.

Table 2.5-4 1.8V Power Sources

2.5.5 Power Connectors

Table 2.5-5 presents the power connectors.

Connector	Comment
JP1	V _{DD} (2.4 V ~ 5 V) connector on the NuMaker-MS51PC.
JP2	V _{SS} connector on the NuMaker-MS51PC.

Table 2.5-5 Power Connectors

2.5.6 USB Connectors

Table 2.5-6 presents the USB connectors.

Connector	Comment
ICEJ3	ICE USB connector on Nu-Link2-Me for power supply, debugging and programming from PC.
J2	USB power connector on NuMaker-MS51PC for power supply.

Table 2.5-6 USB Connectors

2.5.7 Power Switches

Table 2.5-7 presents the power switches.

Switch	Comment
ICEJPR1	Configures the target chip operating voltage at 1.8 V / 3.3 V / 5 V.
ICEJPR2	Configures the ICE chip operating voltage at 1.8 V / 3.3 V.
SW2	Configures the target chip operating voltage at 3.3 V / 5 V.

Table 2.5-7 Power Switches

2.5.8 Power Supply Models

2.5.8.1 External Power Supply through Nu-Link2-Me to Target Chip

The external power supply source on Nu-Link2-Me is shown in Figure 2.5-1.



Figure 2.5-1 External Power Supply Sources on Nu-Link2-Me

To use ICEJ3 as external power supply source with Nu-Link2-Me, please follow the below steps:

1. Solder the resistor on ICEJPR1 (MCUVCC) depends on the target chip operating voltage.
2. Solder the resistor on ICEJPR2 (ICEVCC) depends on the ICE chip operating voltage.
3. Switch the SW2 to OFF.
4. Connect the external power supply to JP1.

Table 2.5-8 presents all power models when supplies external power through Nu-Link2-Me. The Nu-Link2-Me external power sources are highlighted in yellow.

Model	Target Chip Voltage	ICEJ3	ICEJPR1 (MCUVCC) Selection ^[1]	ICEJPR2 (ICEVCC) Selection ^[2]	ICE Chip Voltage	SW2 Selection	J2	Vin	JP1
1	1.8 V	Connect to PC	1.8 V	1.8 V	1.8 V	Off	Ignore	Ignore	1.8 V output
2	3.3 V	Connect to PC	3.3 V (default)	3.3 V (default)	3.3 V	Off	Ignore	Ignore	3.3 V output
3	5 V	Connect to PC	5V	3.3 V (default)	3.3 V	Off	Ignore	Ignore	5 V output
X: Unused. Note: 1. 0 Ω should be soldered between ICEJPR1's MCVCC and 1.8 V / 3.3 V / 5 V. 2. 0 Ω should be soldered between ICEJPR2's ICEVCC and 1.8 V / 3.3 V.									

Table 2.5-8 Supply External Power through Nu-Link2-Me

2.5.8.2 External Power Supply through MS51 platform to Target Chip

The external power supply sources on MS51 platform are shown in Figure 2.5-2.

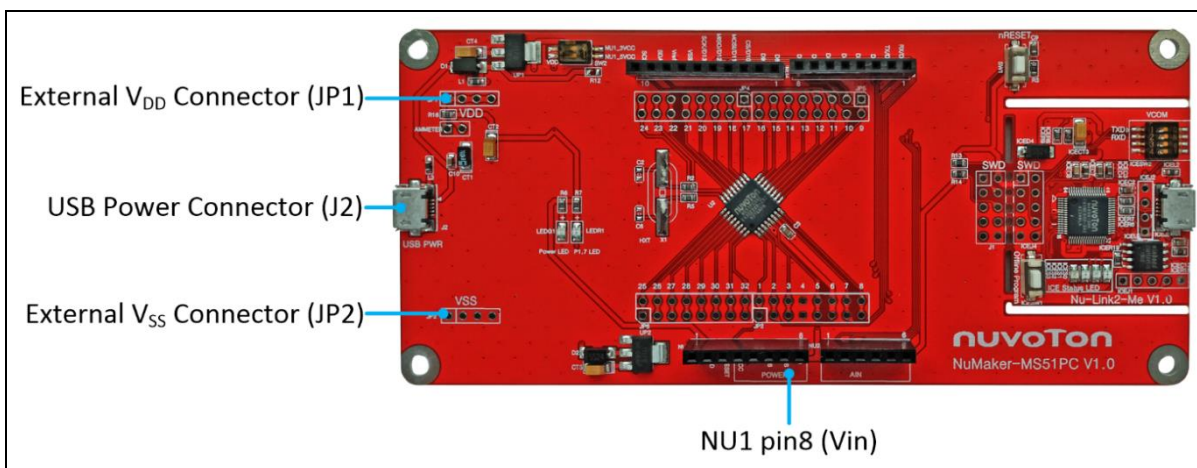

Figure 2.5-2 External Power Supply Sources on MS51 Platform

To use Vin or J2 as external power supply source, please follow the below steps:

1. Switch the SW2 depends on the target chip operating voltage.
2. Remove the resistor on ICEJPR1 (MCUVCC).
3. Solder the resistor on ICEJPR2 (ICEVCC) depends on the ICE chip operating voltage.
4. Connect the external power supply to Vin or J2.

To use JP1 as external power supply source, please follow the below steps:

1. Switch the SW2 to OFF.
2. Remove the resistor on ICEJPR1 (MCUVCC).
3. Solder the resistor on ICEJPR2 (ICEVCC) depends on the ICE chip operating voltage.
4. Connect ICEJ3 to PC.
5. Connect the external power supply to JP1.

To use Vin or J2 as external power supply source with Nu-Link2-Me separated from NuMaker-MS51PC, please follow the below steps:

1. Switch the SW2 depends on the target chip operating voltage.
2. Separate the Nu-Link2-Me from NuMaker-MS51PC.
3. Connect the external power supply to Vin or J2.

To use JP1 as external power supply source with Nu-Link2-Me separated from NuMaker-MS51PC, please follow the below steps:

1. Switch the SW2 to OFF.
2. Separate the Nu-Link2-Me from NuMaker-MS51PC.
3. Connect the external power supply to JP1.

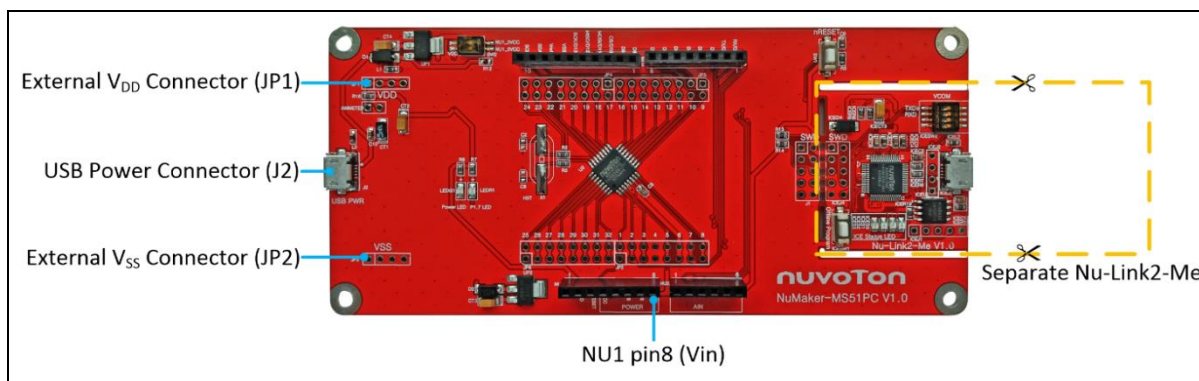

Figure 2.5-3 Separate the Nu-Link2-Me from NuMaker-MS51PC

Table 2.5-9 presents all power models when supplies external power through MS51 platform. The MS51 platform external power sources are highlighted in yellow.

Model	Target Chip Voltage	Vin ^[1]	J2	ICEJ3	SW2 Selection	JP1	ICEJPR1 (MCUVCC) Selection ^[2]	ICEJPR2 (ICEVCC) Selection ^[3]	ICE Chip Voltage ^[4]
4	3.3 V	7 V ~ 12 V Input	X	Ignore	NU1 3VCC	3.3 V output	Remove resistor	3.3 V	3.3 V
5	3.3 V	X	Connect to PC	Ignore	NU1 3VCC	3.3 V output	Remove resistor	3.3 V	3.3 V
6	5 V	7 V ~ 12 V Input	X	Ignore	NU1 5VCC	5 V output	Remove resistor	3.3 V	3.3 V
7	5 V	X	Connect to PC	Ignore	NU1 5VCC	5 V output	Remove resistor	3.3 V	3.3 V
8	1.8 V ~ 3.6 V	Ignore ^[5]	Ignore ^[5]	Connect to PC	OFF	DC Input 1.8 V ~ 3.6 V	Remove resistor	1.8 V / 3.3 V	1.8 V / 3.3 V
9	1.8 V ~ 3.6 V	Ignore ^[5]	Ignore ^[5]	Nu-Link2-Me removed	OFF	DC Input 1.8 V ~ 3.6 V	X	X	X

X: Unused.

Note:

- The Vin input voltage will be converted by voltage regulator UP2 to 5 V.
- 0Ω should be removed from ICEJPR1's MCVCC and 1.8 V / 3.3 V / 5 V.
- 0Ω should be soldered between ICEJPR2's ICEVCC and 1.8 V / 3.3 V.
- The ICE chip voltage should be close to the target chip voltage.
- JP1 external power input only provides voltage to target chip. Supply external power to Vin or J2 can provide 5V to NU1 pin5 (5V) and 3.3V to NU1 pin4 (3VCC).

Table 2.5-9 Supply External Power for MS51 platform

2.5.9 Ammeter Connector

Table 2.5-10 presents the ammeter connector.

Connector	Comment
AMMETER	Connector for user to easily measure the target chip power consumption. User needs to remove the R16 resistor.

Table 2.5-10 Ammeter Connector

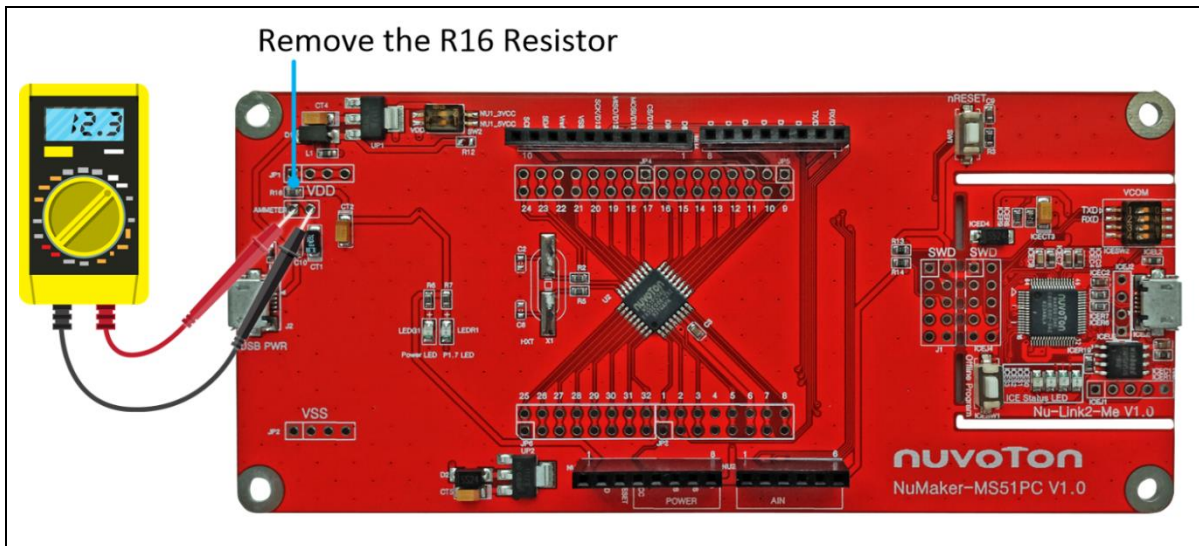

Figure 2.5-4 Wiring between Ammeter Connector and Ammeter

2.5.10 Extension Connectors

Table 2.5-11 presents the extension connectors.

Connector	Comment
JP3, JP4, JP5 and JP6	Full pins extension connectors on the NuMaker-MS51PC.
NU1, NU2, NU3 and NU4	Arduino UNO compatible pins on the NuMaker-MS51PC.

Table 2.5-11 Extension Connectors

2.5.11 Push-Buttons

Table 2.5-12 presents the push-buttons.

Component	Comment
ICESW1	Off-line program button to start off-line programming the target chip.
SW1	Reset button to reset the target chip.

Table 2.5-12 Push-Buttons

2.5.12 LEDs

Table 2.5-13 presents the LEDs.

Component	Comment
Power LED	The power LED indicates that the NuMaker-MS51PC is powered.
P3.5 LED	The LED which is connected to the target chip P3.5.
ICES0, ICES1, ICES2 and ICES3	Nu-Link2-Me status LED.

Table 2.5-13 LEDs

2.6 Nu-Link2-Me

The Nu-Link2-Me is a debugger and programmer that supports on-line programming and debugging through OCD interface. The on-board 16 Mbit SPI Flash allows it to off-line program the target microcontroller. Additionally, the Nu-Link2-Me provides virtual COM port (VCOM) function to print out messages on PC. Table 2.6-1 presents how to set the VCOM function by ICESW2.

ICESW2		
Pin	Function	Comment
1	TXD	On: Connect target chip PB.13 (UART0_TXD) to Nu-Link2-Me. Off: Disconnect target chip PB.13 (UART0_TXD) to Nu-Link2-Me.
2	RXD	On: Connect target chip PB.12 (UART0_RXD) to Nu-Link2-Me. Off: Disconnect target chip PB.12 (UART0_RXD) to Nu-Link2-Me.
Note: Pin 3 and 4 is unused.		

Table 2.6-1 VCOM Function of Nu-Link2-Me

2.7 PCB Placement

Figure 2.7-1 and Figure 2.7-2 show the front and rear placement of NuMaker-M51PC.

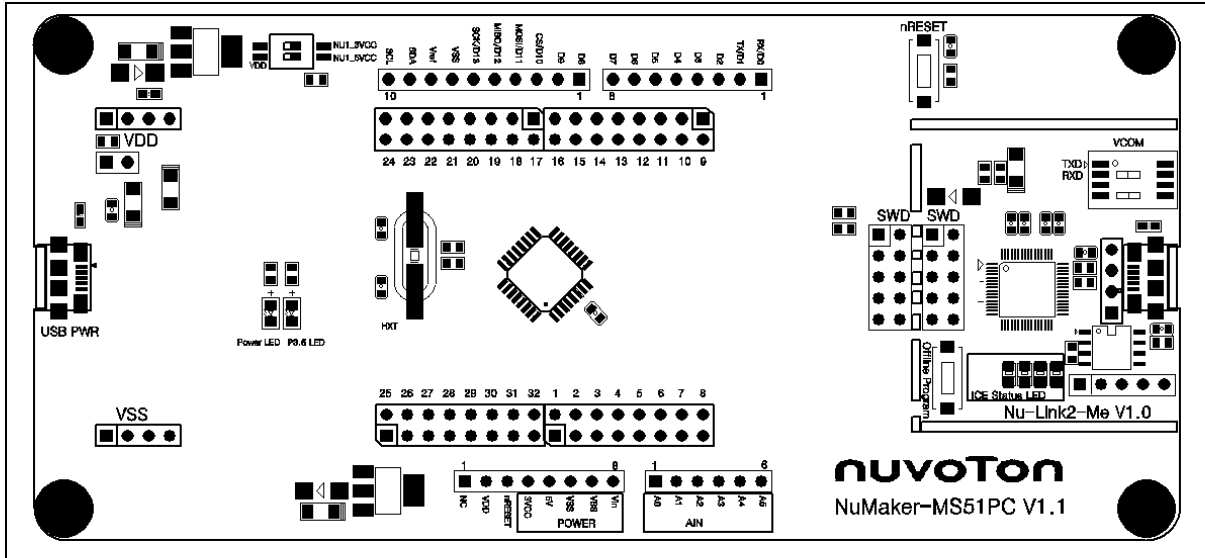

Figure 2.7-1 Front Placement

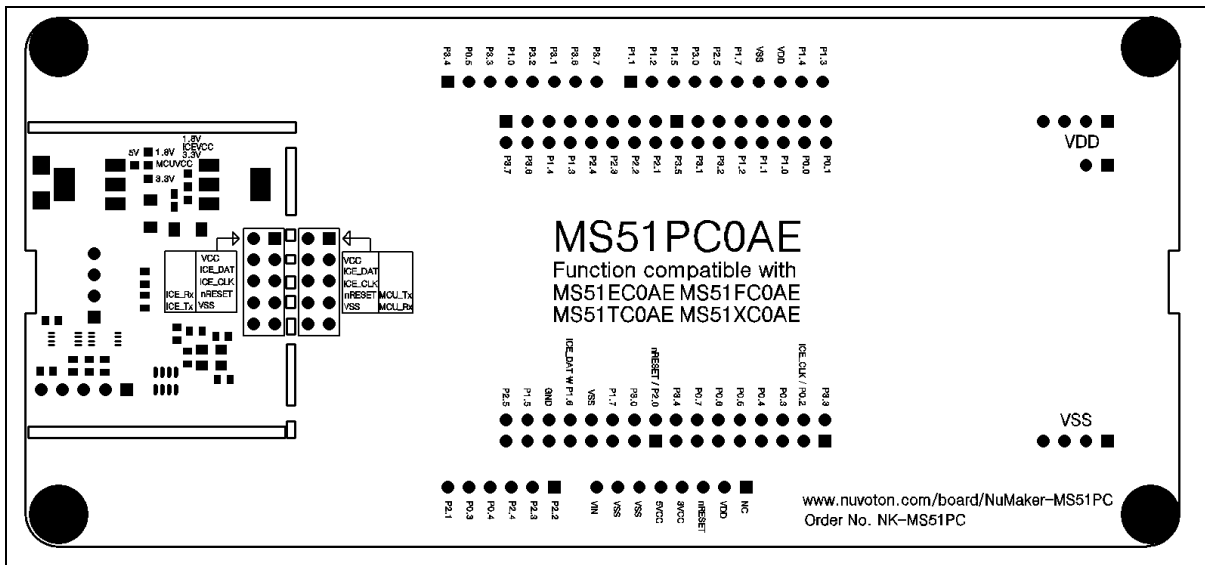

Figure 2.7-2 Rear Placement

3 QUICK START

3.1 Toolchains Supporting

Install the preferred toolchain. Please make sure at least one of the toolchains has been installed.

[KEIL C51](#)

[IAR EW8051](#)

3.2 Nuvoton Nu-Link Driver Installation

Download and install the latest Nuvoton Nu-Link Driver. Please install the Nu-Link USB Driver as well at the end of the installation.

- [Download and install Nu-Link Keil Driver when using Keil C51.](#)
- [Download and install Nu-Link IAR Driver when using IAR EW8051.](#)

Please install the Nu-Link USB Driver as well at the end of the installation. The installation is presented in Figure 3.2-1 and Figure 3.2-2.

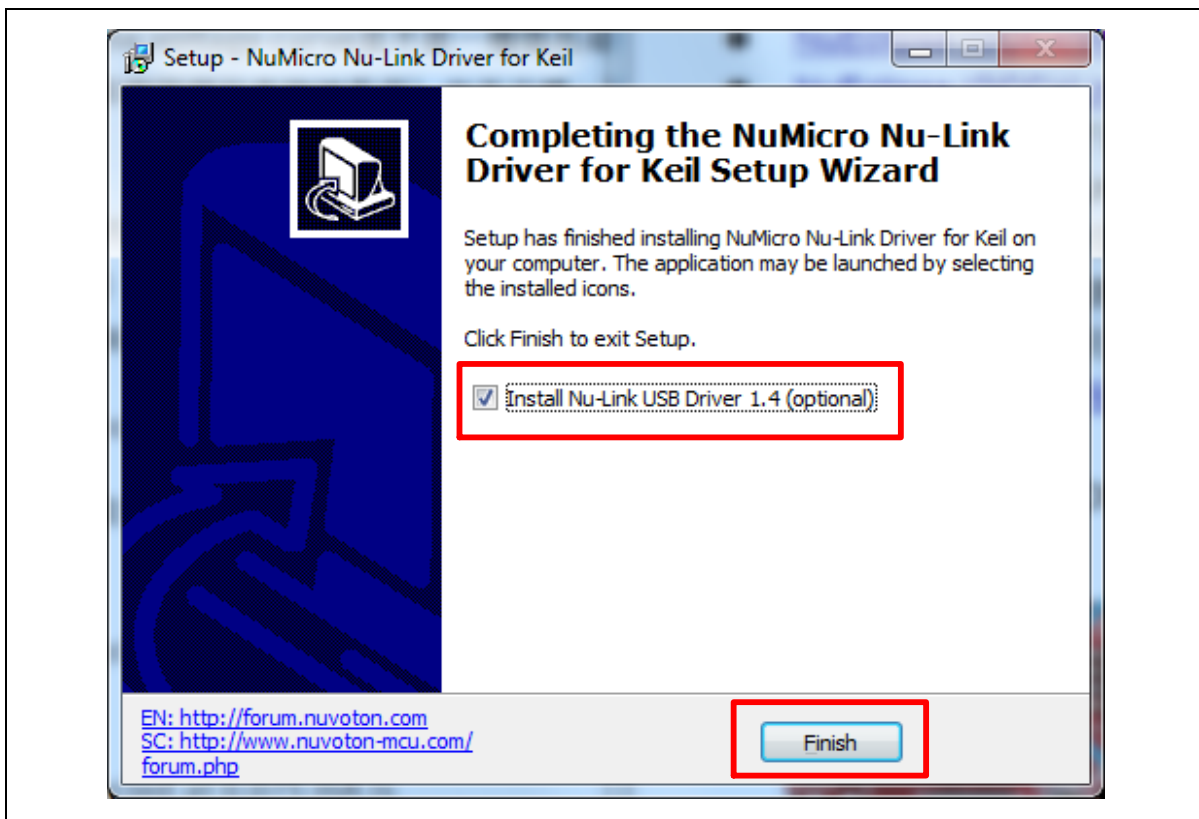

Figure 3.2-1 Nu-Link USB Driver Installation Setup



Figure 3.2-2 Nu-Link USB Driver Installation

3.3 BSP Firmware Download

Download and unzip the Board Support Package (BSP).

- [Download and unzip MS51 Series BSP Keil when using Keil C51.](#)
- [Download and unzip MS51 Series BSP IAR when using IAR EW8051.](#)

3.4 Hardware Setup

1. Open the virtual COM (VCOM) function by changing Nu-Link2-Me VCOM Switch No. 1 and 2 to ON.



Figure 3.4-1 Open VCOM Function

2. Connect the ICE USB connector shown in Figure 3.4-2 to the PC USB port through USB cable.

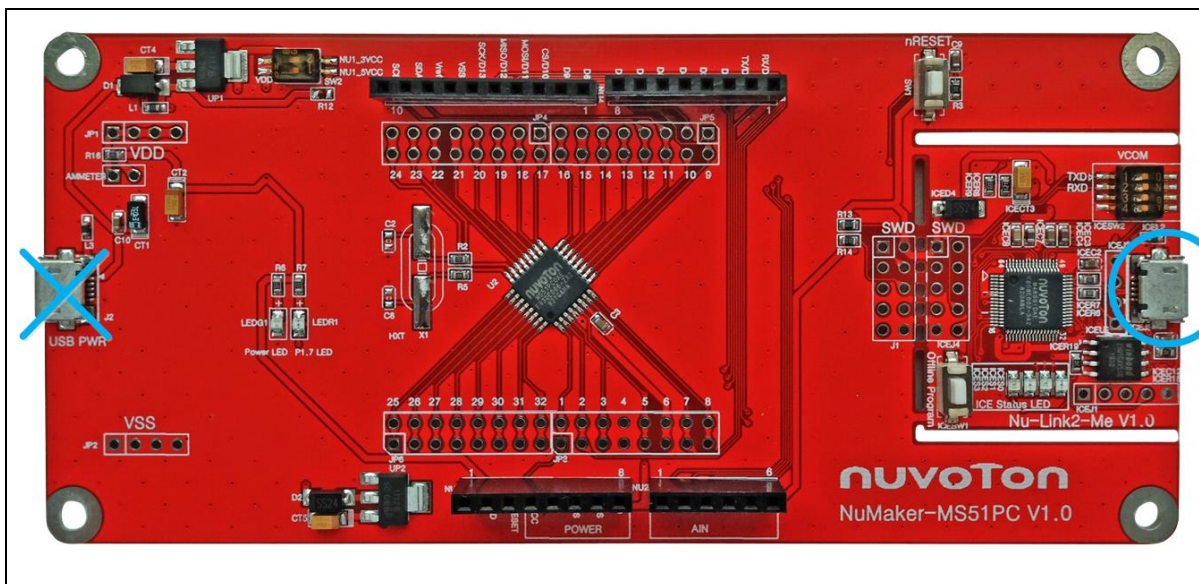

Figure 3.4-2 ICE USB Connector

3. Find the “Nuvoton Virtual COM Port” on the Device Manger as Figure 3.4-3.

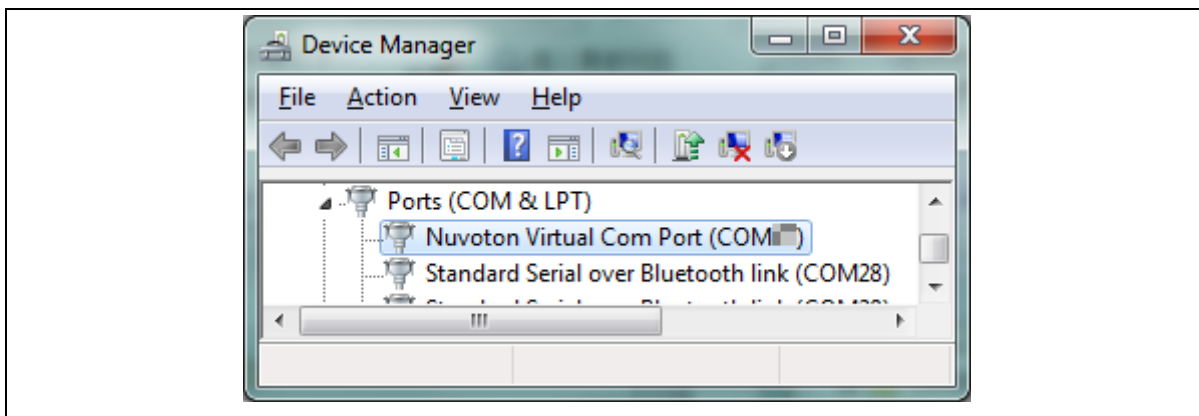

Figure 3.4-3 Device Manger

- 4. Open a serial port terminal, PuTTY for example, to print out debug message. Set the speed to 115200. Figure 3.4-4 presents the PuTTY session setting.

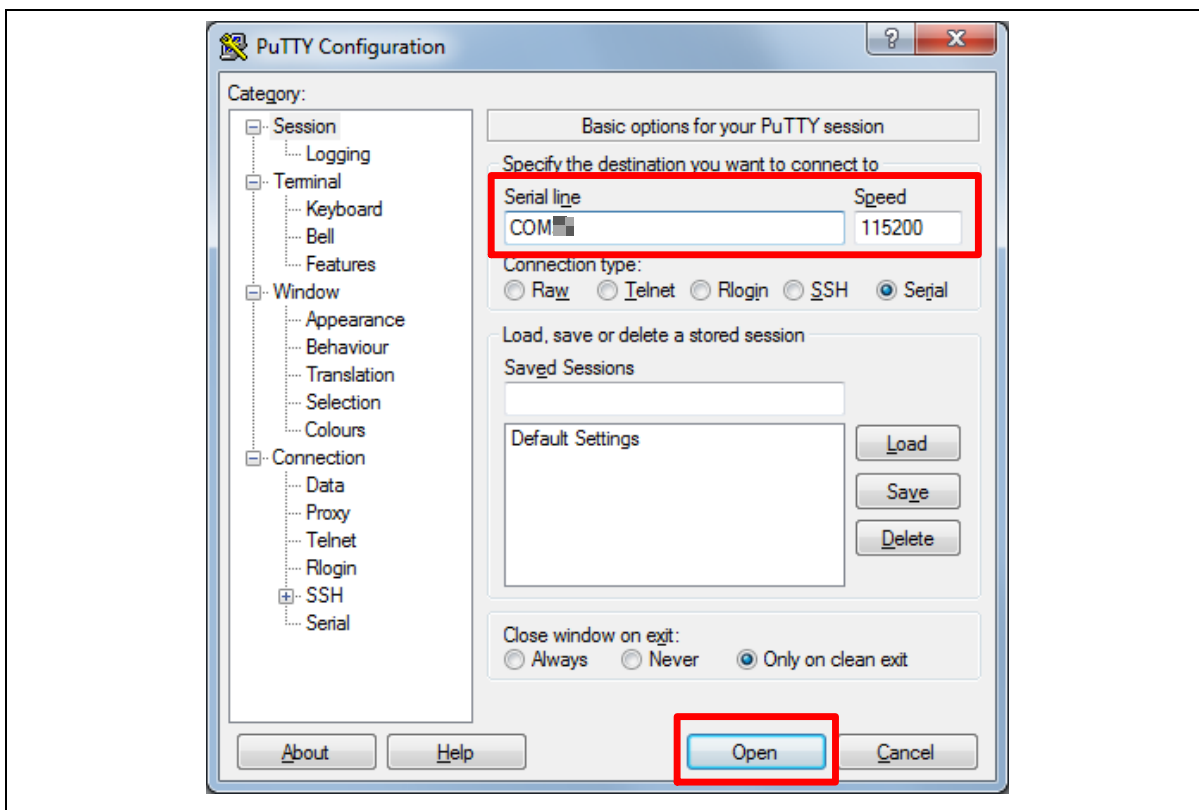

Figure 3.4-4 PuTTY Session Setting

3.5 Find the Example Project

Use the “Template” project as an example. The project can be found under the BSP folder as shown:

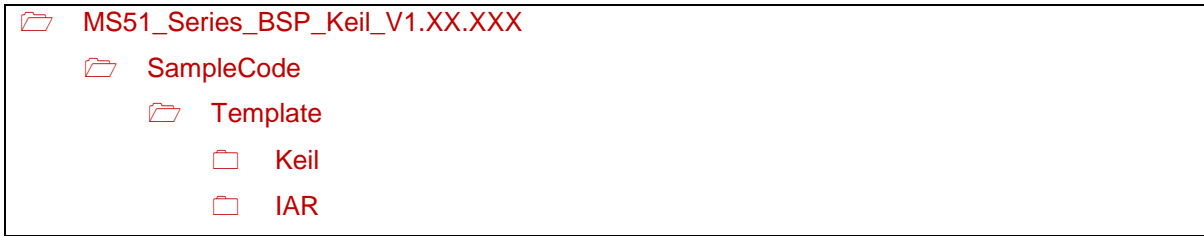

Figure 3-5 Template Project Folder Path

3.6 Execute the Project under Toolchains

Open and execute the project under the toolchain. The section 3.6.1, 3.6.2 describe the steps of executing project in Keil PK51, IAR EW8051 respectively.

3.6.1 Keil PK51

This section provides steps to beginners on how to run a project by using Keil PK51.

Double click the “Template.uvproj” to open the project.

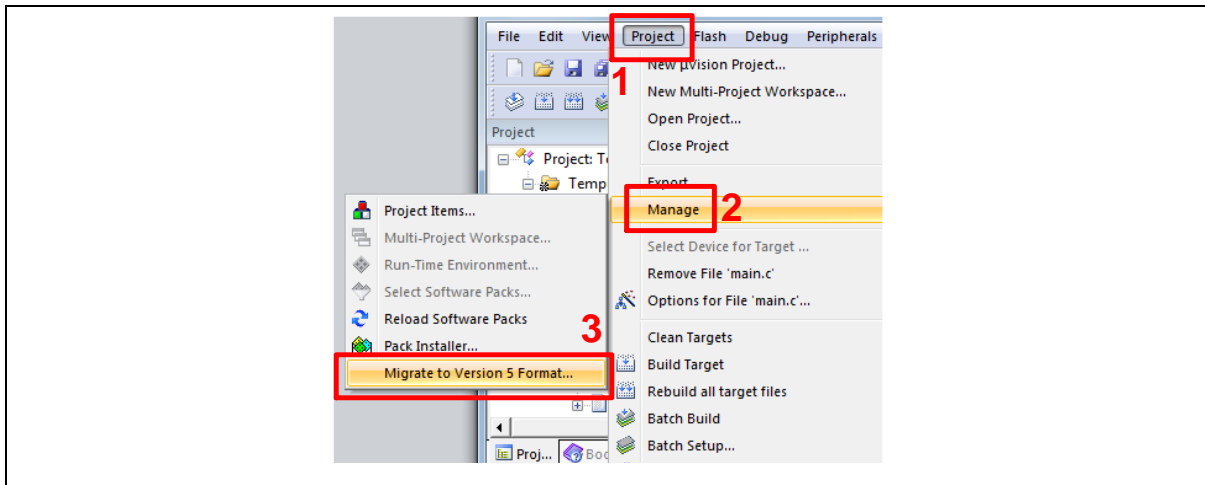

Figure 3.6-1 Project File Migrate to Version 5 Format

1. Make sure the debugger is “Nuvoton Nu-Link Debugger” as shown in Figure 3.6-2 and Figure 3.6-3.

Note: If the dropdown menu in Figure 3.6-2 does not contain “Nuvoton Nu-Link Debugger” item, please rework section 3.6.1.

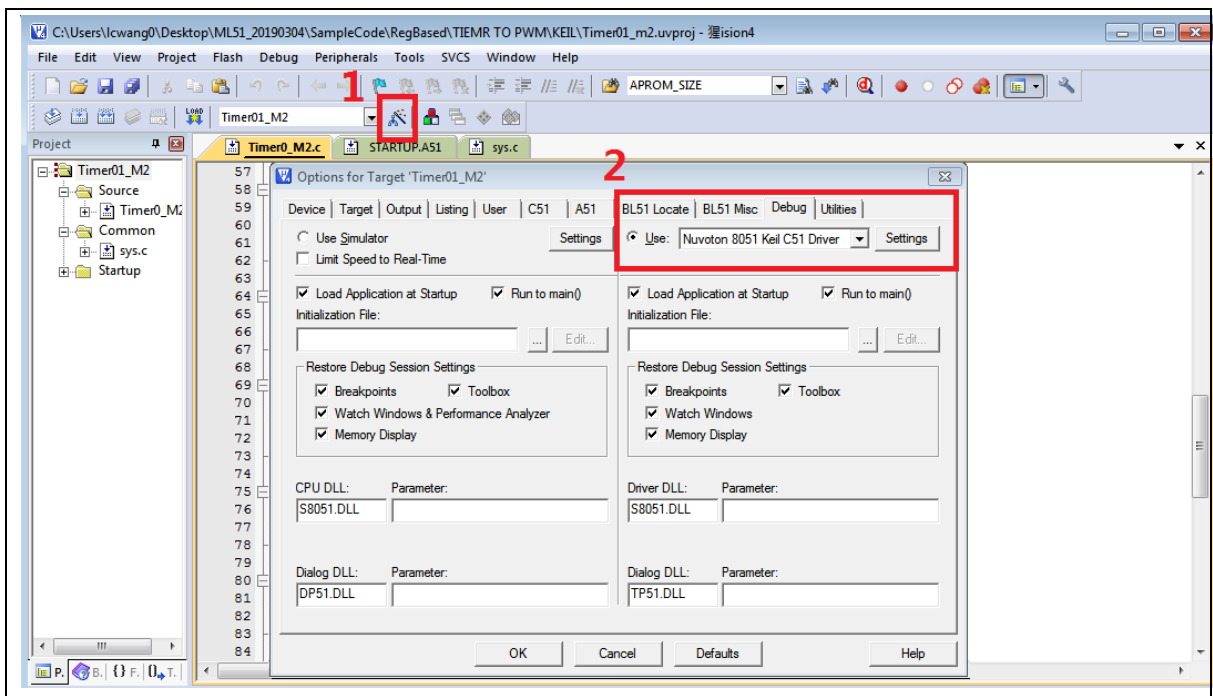

Figure 3.6-2 Debugger Setting in Options Window

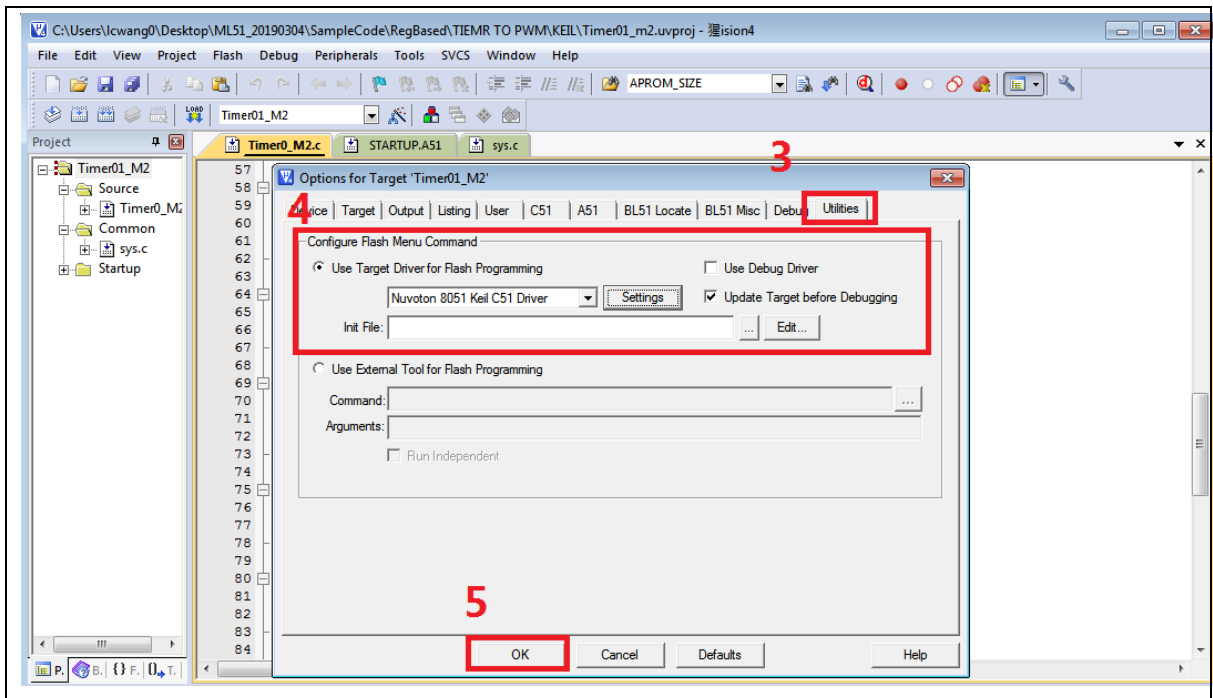

Figure 3.6-3 Programming Setting in Options Window

2. Rebuild all target files. After successfully compile the project, download code to the flash memory. Click “Start/Stop Debug Section” button can enter debug mode.

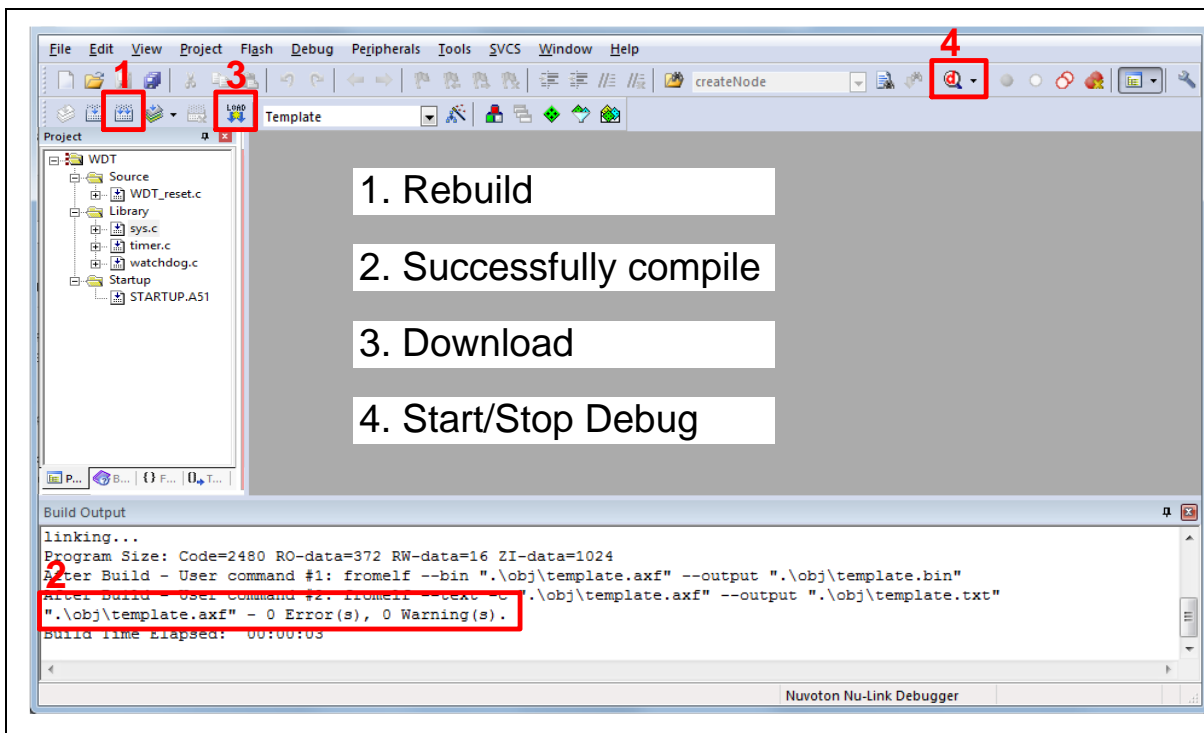

Figure 3.6-4 Compile and Download the Project

3. Figure 3.6-5 shows the debug mode under Keil MDK. Click “Run” and the debug message will be printed out as shown in Figure 3.6-6. User can debug the project under debug mode by checking

source code, assembly language, peripherals' registers, and setting breakpoint, step run, value monitor, etc.

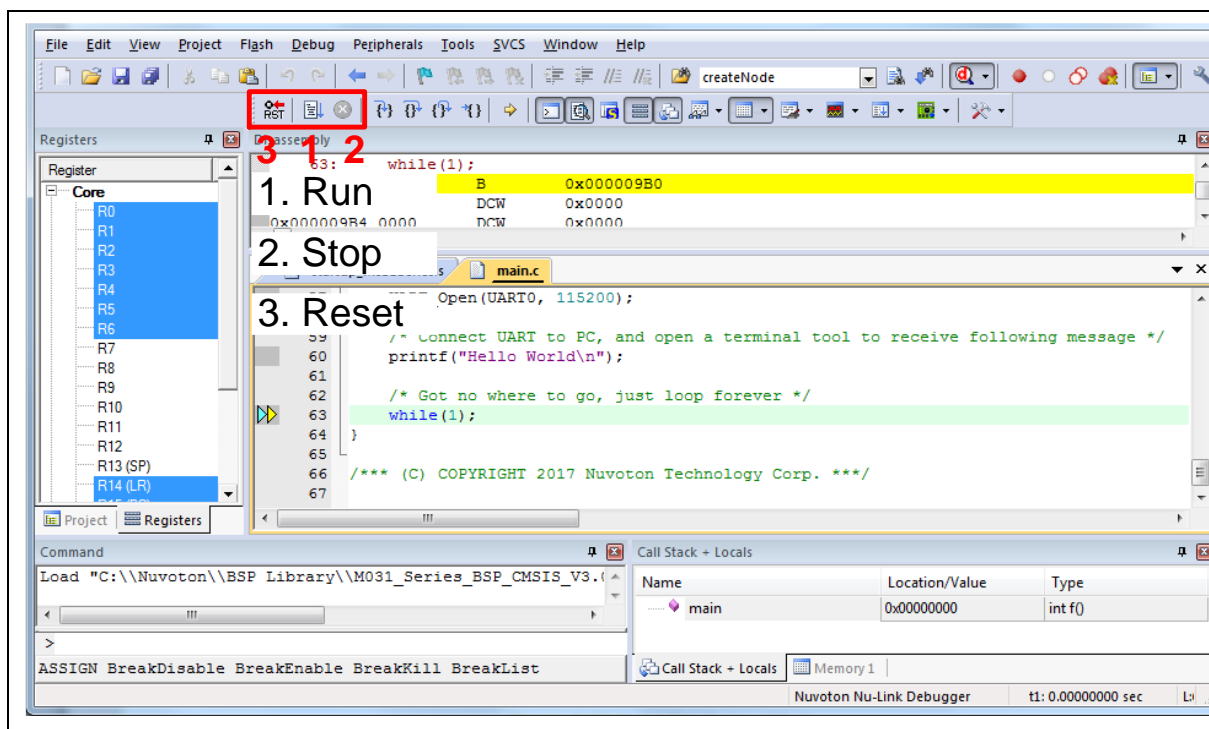

Figure 3.6-5 Keil MDK Debug Mode

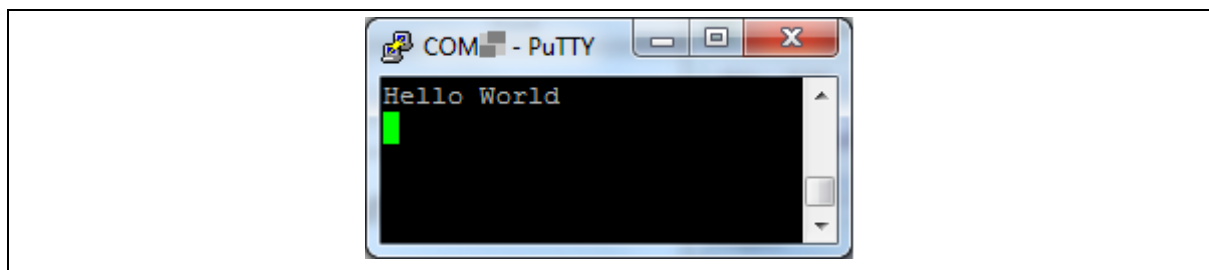

Figure 3.6-6 Debug Message on Serial Port Terminal Windows

3.6.2 IAR EW8051

This section provides steps to beginners on how to run a project by using IAR EW8051.

1. Double click the "Template.eww" to open the project.
2. Make sure the toolbar contain "Nu-Link" item as shown in Figure 3.6-7.

Note: If the toolbar does not contain "Nu-Link" item, please rework section 0.

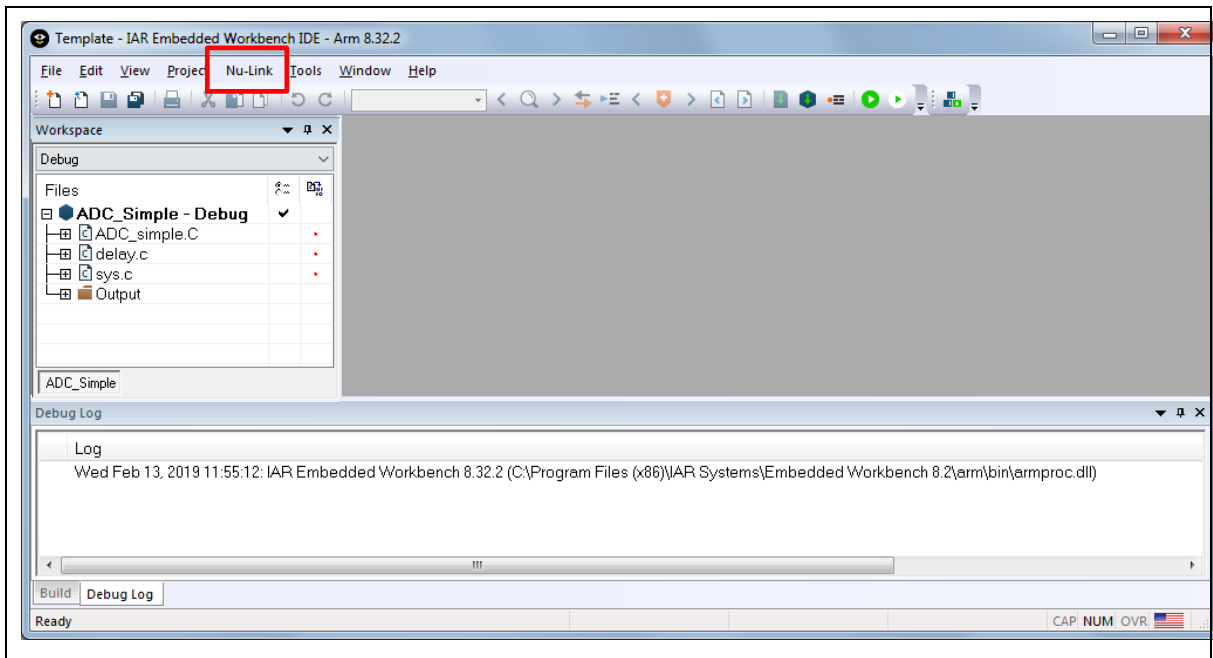

Figure 3.6-7 IAR EW8051 Window

3. Make target file as presented in Figure 3.6-8. After successfully compile the project, download code to the flash memory and enter debug mode.

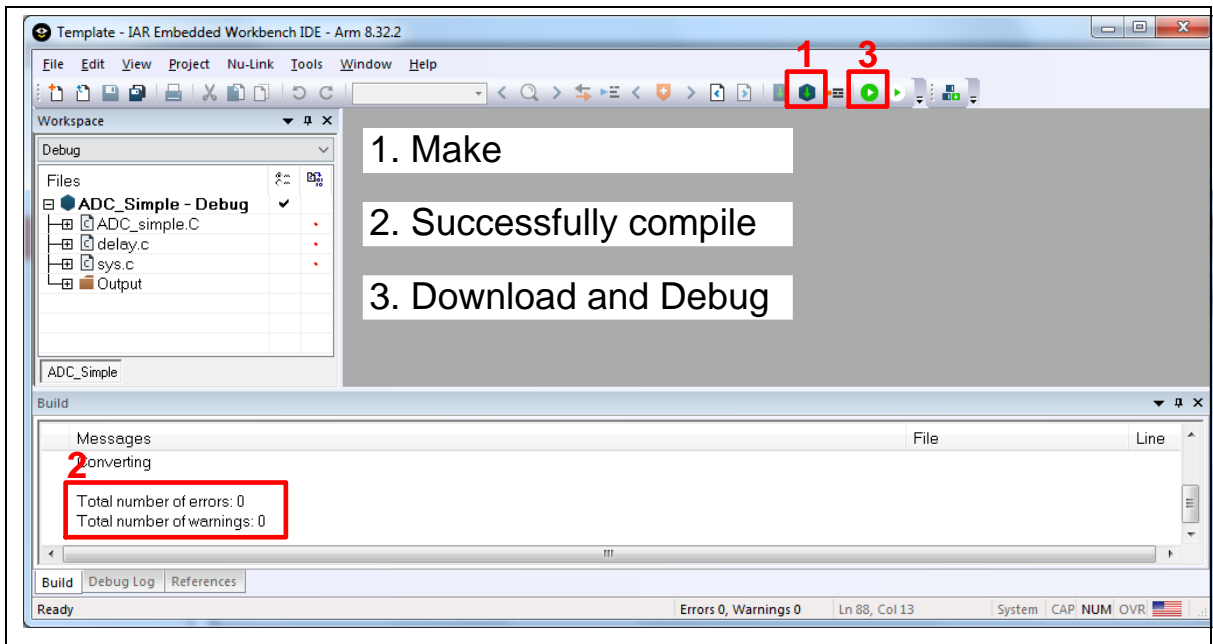

Figure 3.6-8 Compile and Download the Project

4. Figure 3.6-9 shows the debug mode under IAR EW8051. Click “Go” and the debug message will be printed out as shown in Figure 3.6-10. User can debug the project under debug mode by checking source code, assembly language, peripherals’ registers, and setting breakpoint, step run, value monitor, etc.

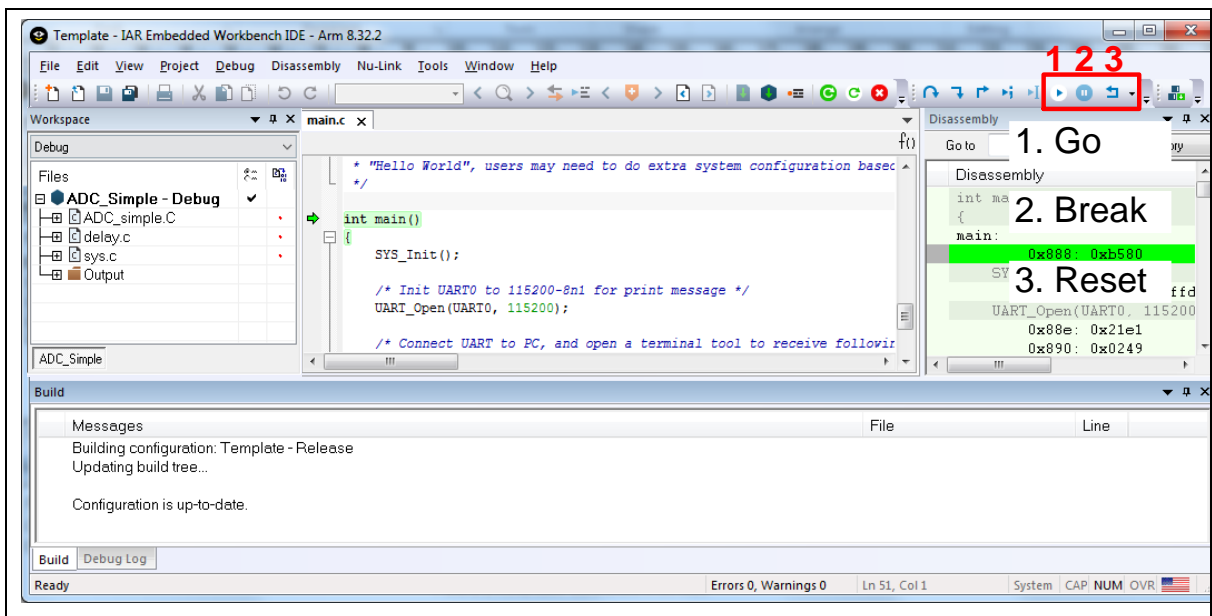

Figure 3.6-9 IAR EW8051 Debug Mode



Figure 3.6-10 Debug Message on Serial Port Terminal Windows

4 NUMAKER-MS51PC SCHEMATICS

4.1 Nu-Link2-Me

Figure 4.1-1 shows the Nu-Link2-Me circuit. The Nu-Link2-Me is a debugger and programmer that supports on-line programming and debugging through OCD interface.

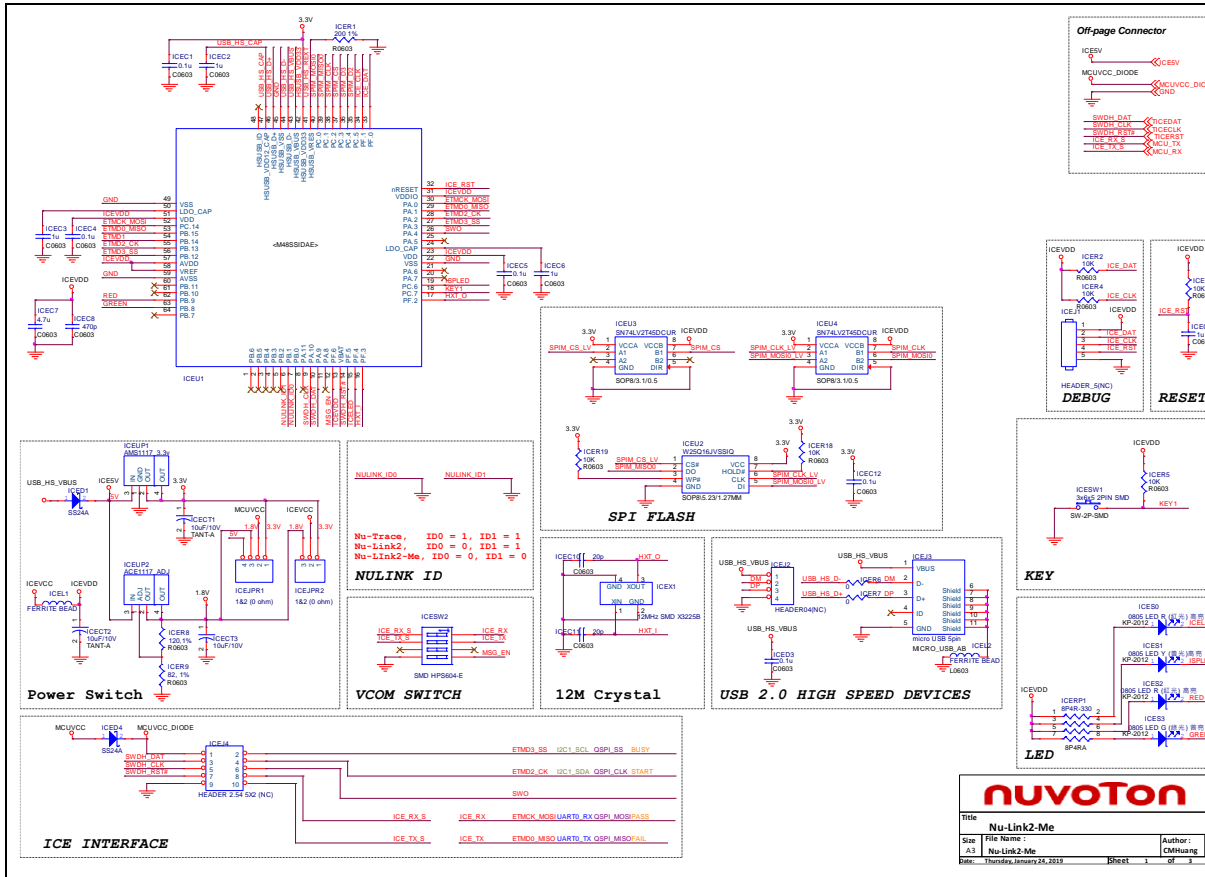

Figure 4.1-1 Nu-Link2-Me Circuit

4.2 MS51 Platform

Figure 4.2-1 shows the MS51 platform circuit.

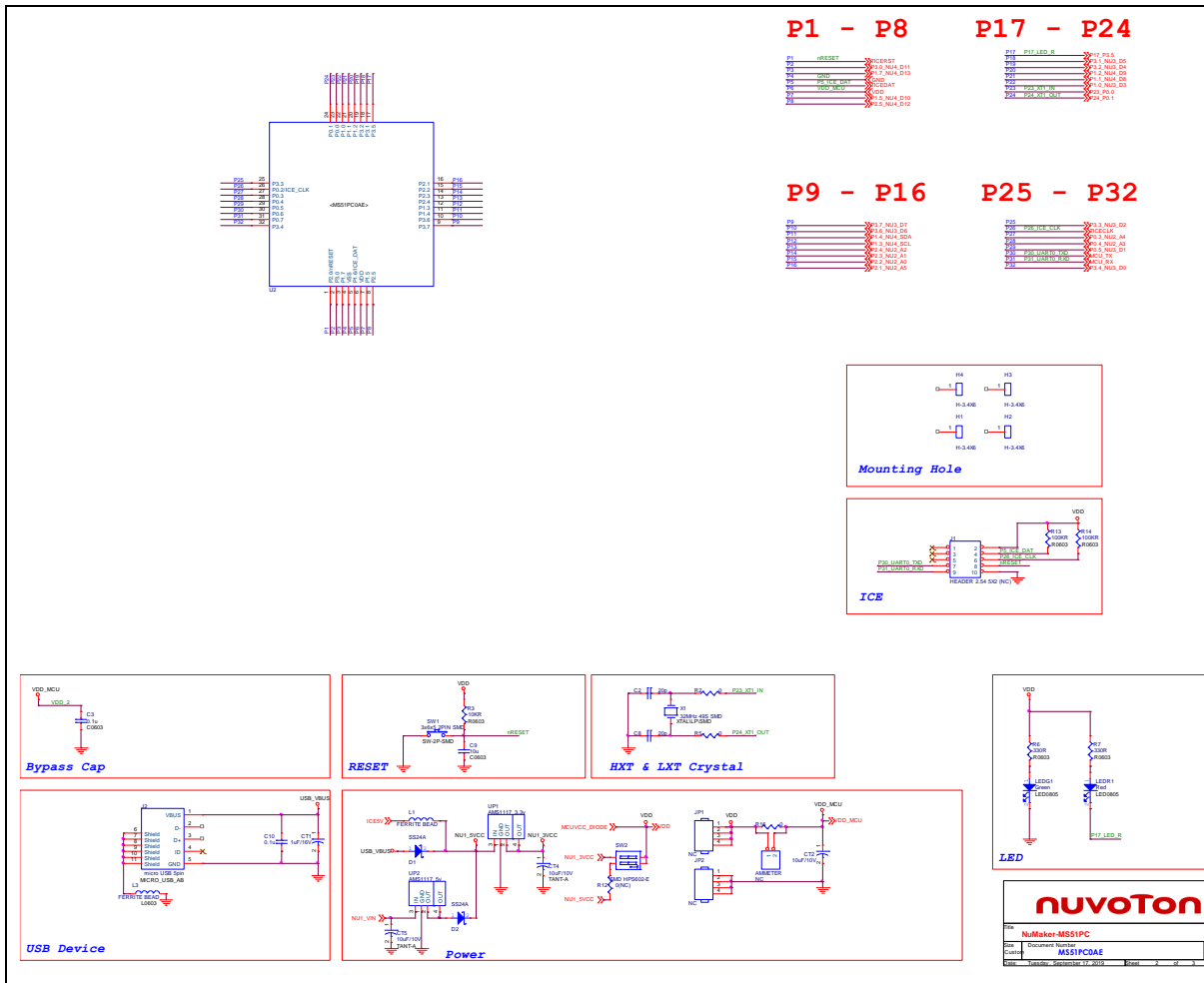

Figure 4.2-1 MS51 Platform Circuit

4.3 Extension Connector

Figure 4.3-1 shows extension connectors of NuMaker-MS51PC.

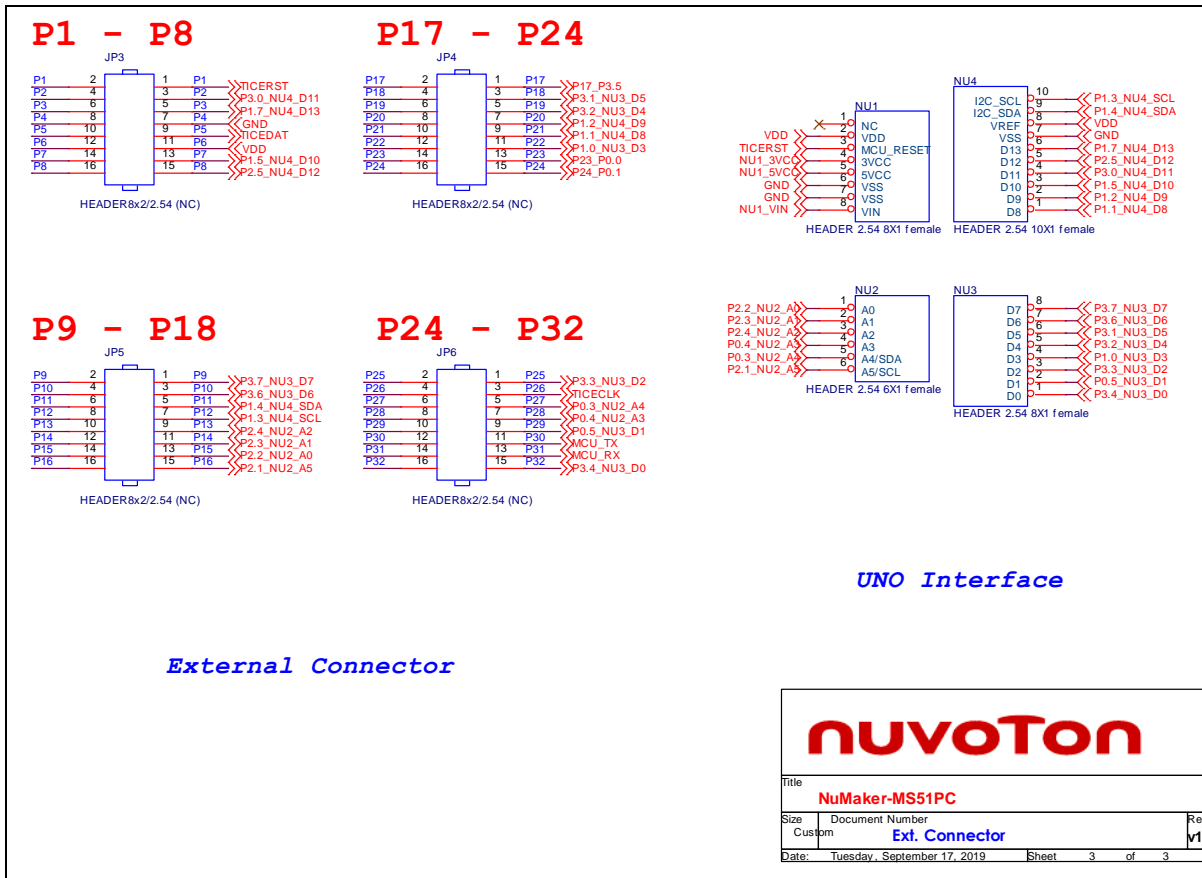

Figure 4.3-1 Extension Connectors Circuit

5 REVISION HISTORY

Date	Revision	Description
2019.08.30	1.00	Initial Release.

Important Notice

Nuvoton Products are neither intended nor warranted for usage in systems or equipment, any malfunction or failure of which may cause loss of human life, bodily injury or severe property damage. Such applications are deemed, "Insecure Usage".

Insecure usage includes, but is not limited to: equipment for surgical implementation, atomic energy control instruments, airplane or spaceship instruments, the control or operation of dynamic, brake or safety systems designed for vehicular use, traffic signal instruments, all types of safety devices, and other applications intended to support or sustain life.

All Insecure Usage shall be made at customer's risk, and in the event that third parties lay claims to Nuvoton as a result of customer's Insecure Usage, customer shall indemnify the damages and liabilities thus incurred by Nuvoton.

*Please note that all data and specifications are subject to change without notice.
All the trademarks of products and companies mentioned in this datasheet belong to their respective owners.*