

# NSR20406NXT5G

## 2 A, 40 V Schottky Barrier Diode

These Schottky barrier diodes are optimized for low forward voltage drop and low leakage current and are offered in a Chip Scale Package (CSP) to reduce board space. The low thermal resistance enables designers to meet the challenging task of achieving higher efficiency and meeting reduced space requirements.

### Features

- Low Forward Voltage Drop – 520 mV (Typ.) @  $I_F = 2$  A
- Low Reverse Current – 35  $\mu$ A (Typ.) @  $V_R = 40$  V
- 2 A of Continuous Forward Current
- ESD Rating – Human Body Model: Class 3B  
– Machine Model: Class C
- High Switching Speed
- These Devices are Pb-Free, Halogen Free/BFR Free and are RoHS Compliant

### Typical Applications

- LCD and Keypad Backlighting
- Camera Photo Flash
- Buck and Boost dc-dc Converters
- Reverse Voltage and Current Protection
- Clamping & Protection

### MAXIMUM RATINGS

| Rating  | Symbol                            | Value | Unit         |         |
|---|-----------------------------------|-------|--------------|---------|
| Reverse Voltage   | $V_R$                             | 40    | V            |         |
| Forward Current (DC)  | $I_F$                             | 2     | A            |         |
| Forward Surge Current<br>(60 Hz @ 1 cycle)                                | $I_{FSM}$                         | 19    | A            |         |
| Repetitive Peak Forward Current<br>(Pulse Wave = 1 sec, Duty Cycle = 66%) | $I_{FRM}$                         | 3.4   | A            |         |
| ESD Rating:   | Human Body Model<br>Machine Model | ESD   | > 8<br>> 400 | kV<br>V |

Stresses exceeding those listed in the Maximum Ratings table may damage the device. If any of these limits are exceeded, device functionality should not be assumed, damage may occur and reliability may be affected.



ON Semiconductor®

[www.onsemi.com](http://www.onsemi.com)

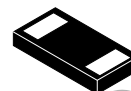

DSN2  
(0603)  
CASE 152AT

### MARKING DIAGRAM

PIN 1



6T = Specific Device Code  
M = Date Code

### PIN CONNECTIONS



### ORDERING INFORMATION

| Device        | Package           | Shipping†          |
|---------------|-------------------|--------------------|
| NSR20406NXT5G | DSN2<br>(Pb-Free) | 5000 / Tape & Reel |

†For information on tape and reel specifications, including part orientation and tape sizes, please refer to our Tape and Reel Packaging Specifications Brochure, BRD8011/D.

# NSR20406NXT5G

## THERMAL CHARACTERISTICS

| Characteristic   | Symbol                   | Min | Typ | Max         | Unit                                     |
|--|--------------------------|-----|-----|-------------|--|
| Thermal Resistance<br>Junction-to-Ambient (Note 1)<br>Total Power Dissipation @ $T_A = 25^\circ\text{C}$ | $R_{\theta JA}$<br>$P_D$ |     |     | 245<br>510  | $^\circ\text{C}/\text{W}$<br>$\text{mW}$ |
| Thermal Resistance<br>Junction-to-Ambient (Note 2)<br>Total Power Dissipation @ $T_A = 25^\circ\text{C}$ | $R_{\theta JA}$<br>$P_D$ |     |     | 90<br>1.4   | $^\circ\text{C}/\text{W}$<br>$\text{W}$  |
| Storage Temperature Range  | $T_{\text{stg}}$         |     |     | -40 to +125 | $^\circ\text{C}$                         |
| Junction Temperature   | $T_J$                    |     |     | +150        | $^\circ\text{C}$                         |

1. Mounted onto a 4 in square FR-4 board 50 mm sq. 1 oz. Cu 0.06" thick single sided. Operating to steady state.
2. Mounted onto a 4 in square FR-4 board 650 mm sq. 1 oz. Cu 0.06" thick single sided. Operating to steady state.

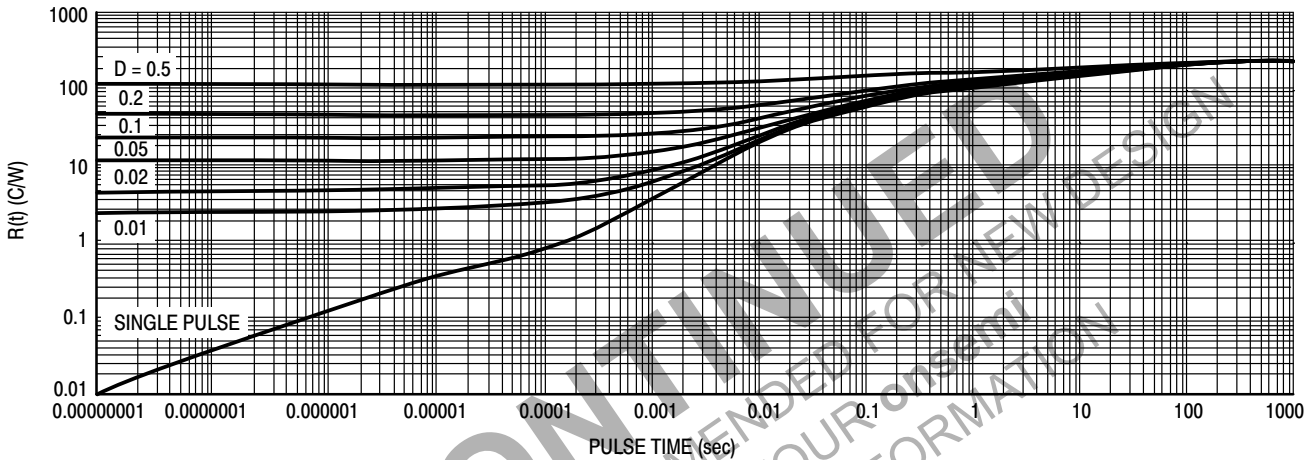

Figure 1. Thermal Response (Note 1)

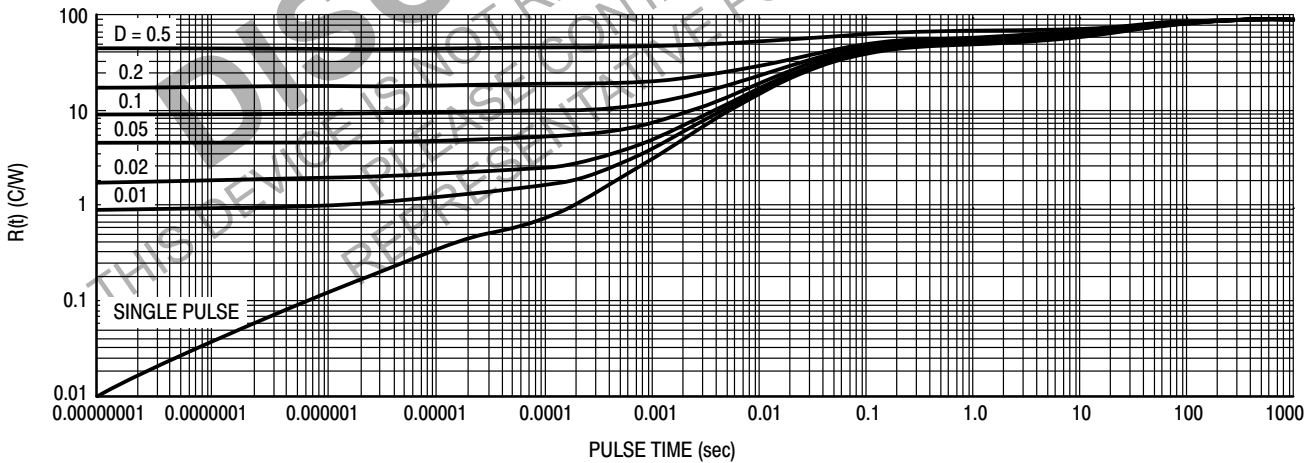

Figure 2. Thermal Response (Note 2)

# NSR20406NXT5G

## ELECTRICAL CHARACTERISTICS (T<sub>A</sub> = 25°C unless otherwise noted)

| Characteristic  | Symbol           | Min                   | Typ                             | Max                             | Unit |
|---|------------------|-----------------------|---------------------------------|---------------------------------|------|
| Reverse Leakage<br>(V <sub>R</sub> = 10 V)<br>(V <sub>R</sub> = 40 V)   | I <sub>R</sub>   | -<br>-                | 3<br>35                         | 15<br>150                       | μA   |
| Forward Voltage<br>(I <sub>F</sub> = 10 mA)<br>(I <sub>F</sub> = 100 mA)<br>(I <sub>F</sub> = 500 mA)<br>(I <sub>F</sub> = 1 A)<br>(I <sub>F</sub> = 2 A) | V <sub>F</sub>   | -<br>-<br>-<br>-<br>- | 240<br>310<br>380<br>430<br>520 | 280<br>350<br>420<br>470<br>550 | mV   |
| Total Capacitance (V <sub>R</sub> = 2.0 V, f = 1.0 MHz)   | C <sub>T</sub>   | -                     | 140                             | -                               | pF   |
| Reverse Recovery Time (I <sub>F</sub> = I <sub>R</sub> = 10 mA, I <sub>R(REC)</sub> = 1.0 mA, Figure 3)   | t <sub>rr</sub>  | -                     | 53                              | -                               | ns   |
| Peak Forward Recover Voltage (I <sub>F</sub> = 100 mA, t <sub>r</sub> = 20 ns, Figure 4)  | V <sub>FRM</sub> | -                     | 440                             | -                               | mV   |

Product parametric performance is indicated in the Electrical Characteristics for the listed test conditions, unless otherwise noted. Product performance may not be indicated by the Electrical Characteristics if operated under different conditions.

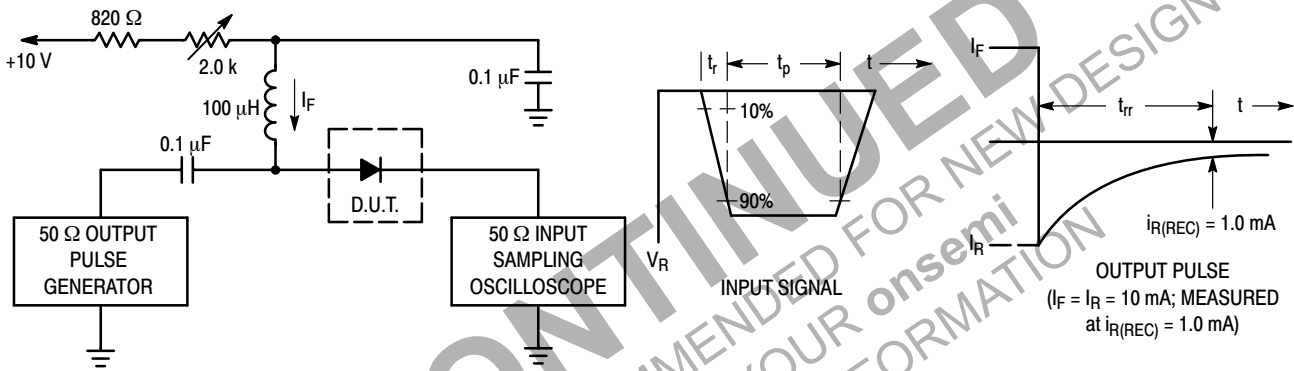

- Notes: 1. A 2.0 kΩ variable resistor adjusted for a Forward Current (I<sub>F</sub>) of 10 mA.  
 2. Input pulse is adjusted so I<sub>R(peak)</sub> is equal to 10 mA.  
 3. t<sub>p</sub> » t<sub>rr</sub>

Figure 3. Recovery Time Equivalent Test Circuit

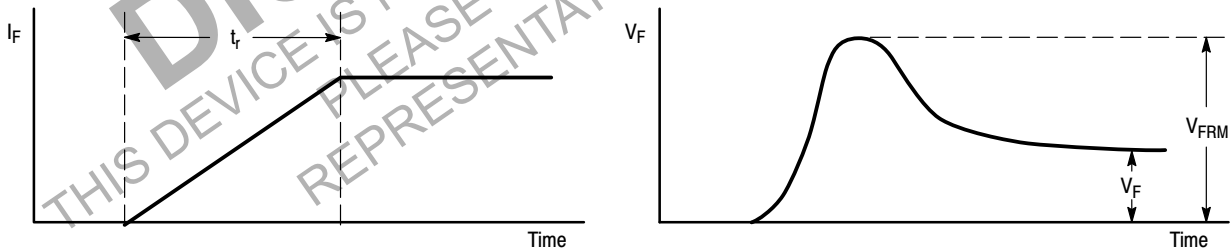

Figure 4. Peak Forward Recover Voltage Definition

TYPICAL CHARACTERISTICS

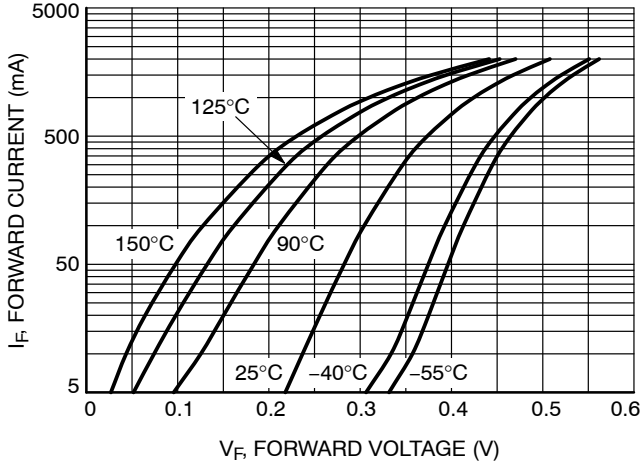

Figure 5. Forward Voltage

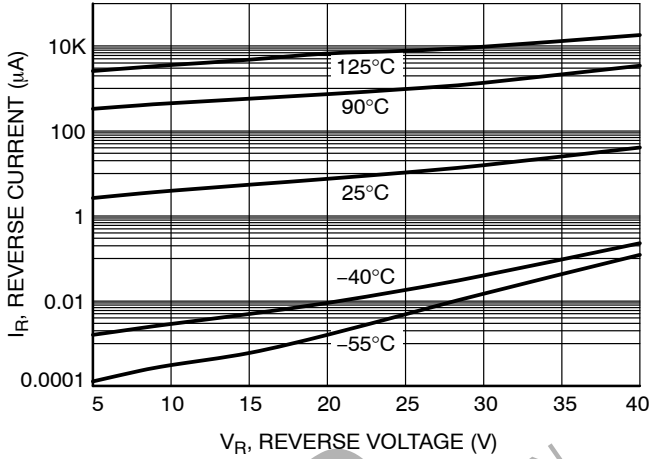

Figure 6. Leakage Current

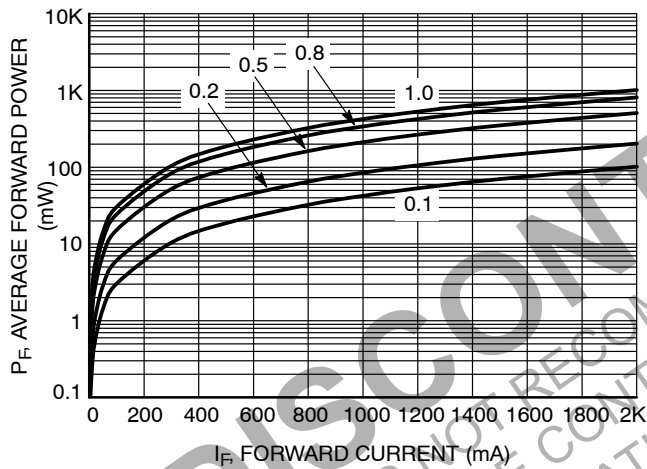

Figure 7. Average Forward Power Dissipation

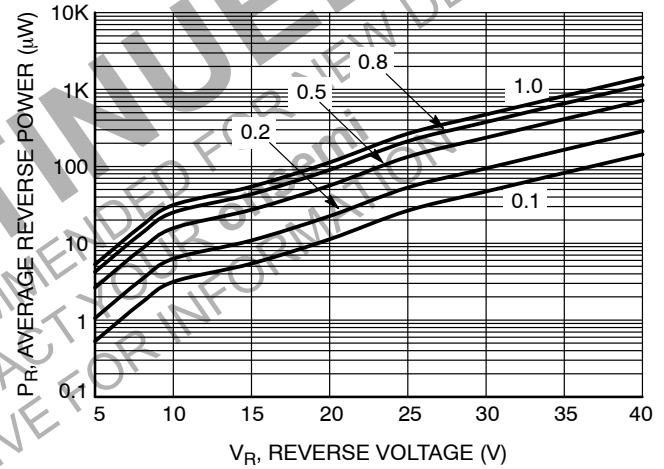

Figure 8. Average Reverse Power Dissipation

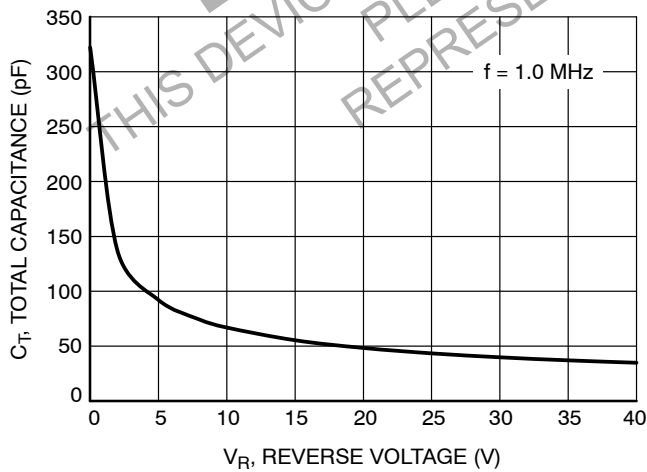

Figure 9. Total Capacitance

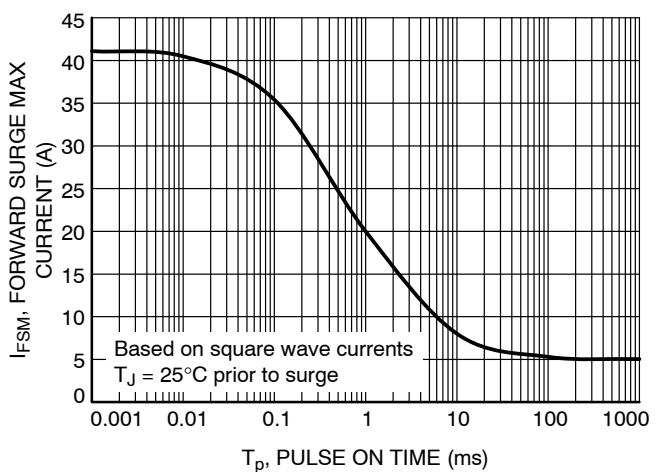
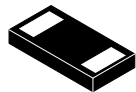

Figure 10. Forward Surge Maximum



SCALE 8:1

**DSN2, 1.6x0.8, 1.2P, (0603)**  
**CASE 152AT**  
**ISSUE A**

DATE 03 JUN 2016

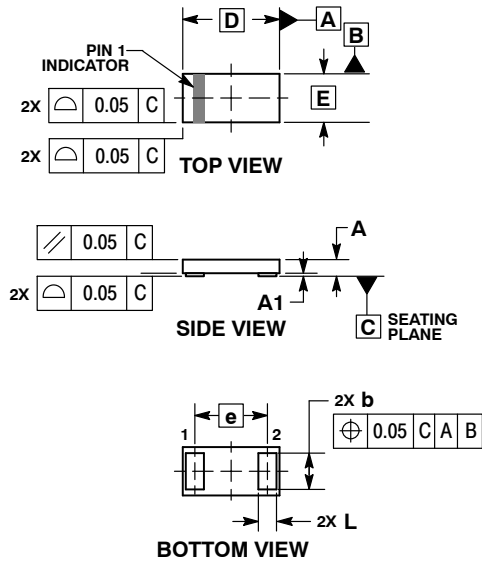

- NOTES:  
1. DIMENSIONING AND TOLERANCING PER ASME Y14.5M, 1994.  
2. CONTROLLING DIMENSION: MILLIMETERS.

| MILLIMETERS |          |      |
|-------------|----------|------|
| DIM         | MIN      | MAX  |
| A           | 0.25     | 0.31 |
| A1          | 0.00     | 0.05 |
| b           | 0.55     | 0.65 |
| D           | 1.60 BSC |      |
| E           | 0.80 BSC |      |
| e           | 1.20 BSC |      |
| L           | 0.25     | 0.35 |

**GENERIC MARKING DIAGRAM1\***

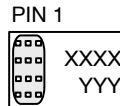

XXXX = Specific Device Code  
YYY = Year Code

**GENERIC MARKING DIAGRAM2\***

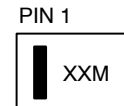

XX = Specific Device Code  
M = Date Code

\*This information is generic. Please refer to device data sheet for actual part marking. Pb-Free indicator, "G", may or not be present.

**RECOMMENDED MOUNTING FOOTPRINT\***

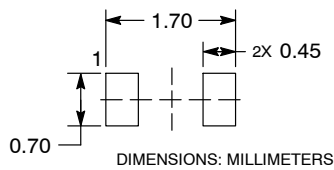

See Application Note [AND8464/D](#) for more mounting details

\*For additional information on our Pb-Free strategy and soldering details, please download the onsemi Soldering and Mounting Techniques Reference Manual, [SOLDERRM/D](#).

**CATHODE BAND MONTH CODING**

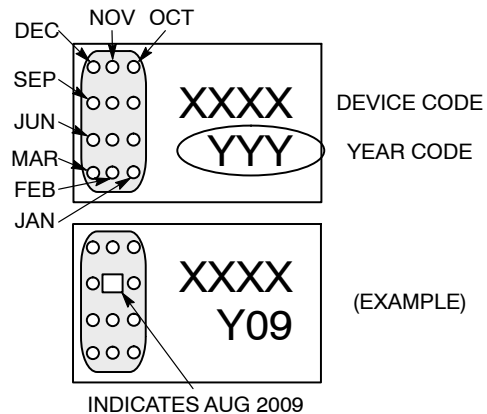

|                         |                                    |  |
|-------------------------|------------------------------------|--|
| <b>DOCUMENT NUMBER:</b> | <b>98AON79729F</b>                 | Electronic versions are uncontrolled except when accessed directly from the Document Repository. Printed versions are uncontrolled except when stamped "CONTROLLED COPY" in red. |
| <b>DESCRIPTION:</b>     | <b>DSN2, 1.6X0.8, 1.2P, (0603)</b> | <b>PAGE 1 OF 1</b>   |

onsemi and ONSEMI are trademarks of Semiconductor Components Industries, LLC dba onsemi or its subsidiaries in the United States and/or other countries. onsemi reserves the right to make changes without further notice to any products herein. onsemi makes no warranty, representation or guarantee regarding the suitability of its products for any particular purpose, nor does onsemi assume any liability arising out of the application or use of any product or circuit, and specifically disclaims any and all liability, including without limitation special, consequential or incidental damages. onsemi does not convey any license under its patent rights nor the rights of others.

**onsemi**, **Onsemi**, and other names, marks, and brands are registered and/or common law trademarks of Semiconductor Components Industries, LLC dba "**onsemi**" or its affiliates and/or subsidiaries in the United States and/or other countries. **onsemi** owns the rights to a number of patents, trademarks, copyrights, trade secrets, and other intellectual property. A listing of **onsemi**'s product/patent coverage may be accessed at [www.onsemi.com/site/pdf/Patent-Marking.pdf](http://www.onsemi.com/site/pdf/Patent-Marking.pdf). **onsemi** reserves the right to make changes at any time to any products or information herein, without notice. The information herein is provided "as-is" and **onsemi** makes no warranty, representation or guarantee regarding the accuracy of the information, product features, availability, functionality, or suitability of its products for any particular purpose, nor does **onsemi** assume any liability arising out of the application or use of any product or circuit, and specifically disclaims any and all liability, including without limitation special, consequential or incidental damages. Buyer is responsible for its products and applications using **onsemi** products, including compliance with all laws, regulations and safety requirements or standards, regardless of any support or applications information provided by **onsemi**. "Typical" parameters which may be provided in **onsemi** data sheets and/or specifications can and do vary in different applications and actual performance may vary over time. All operating parameters, including "Typicals" must be validated for each customer application by customer's technical experts. **onsemi** does not convey any license under any of its intellectual property rights nor the rights of others. **onsemi** products are not designed, intended, or authorized for use as a critical component in life support systems or any FDA Class 3 medical devices or medical devices with a same or similar classification in a foreign jurisdiction or any devices intended for implantation in the human body. Should Buyer purchase or use **onsemi** products for any such unintended or unauthorized application, Buyer shall indemnify and hold **onsemi** and its officers, employees, subsidiaries, affiliates, and distributors harmless against all claims, costs, damages, and expenses, and reasonable attorney fees arising out of, directly or indirectly, any claim of personal injury or death associated with such unintended or unauthorized use, even if such claim alleges that **onsemi** was negligent regarding the design or manufacture of the part. **onsemi** is an Equal Opportunity/Affirmative Action Employer. This literature is subject to all applicable copyright laws and is not for resale in any manner.

## ADDITIONAL INFORMATION

### TECHNICAL PUBLICATIONS:

Technical Library: [www.onsemi.com/design/resources/technical-documentation](http://www.onsemi.com/design/resources/technical-documentation)  
onsemi Website: [www.onsemi.com](http://www.onsemi.com)

### ONLINE SUPPORT: [www.onsemi.com/support](http://www.onsemi.com/support)

For additional information, please contact your local Sales Representative at [www.onsemi.com/support/sales](http://www.onsemi.com/support/sales)