



Connectors > Connector Accessories > Connector Seals & Cavity Plugs



Connector Seal & Plug Type: **Single Wire Seal (SWS)**

Cavity Diameter: **5.2 mm [.205 in]**

Operating Temperature Range: **-40 – 130 °C [-40 – 266 °F]**

Primary Product Color: **Blue**

Primary Product Material: **Silicone**

Features

Product Type Features

Connector Seal & Plug Type	Single Wire Seal (SWS)
----------------------------	------------------------

Body Features

Primary Product Color	Blue
Primary Product Material	Silicone

Dimensions

Cavity Diameter	5.2 mm [.205 in]
Compatible Insulation Diameter Range	1.2 – 2.1 mm [.047 – .083 in]

Usage Conditions

Operating Temperature Range	-40 – 130 °C [-40 – 266 °F]
Operating Temperature (Max)	130 °C [266 °F]

Other

Resistance to Hydrocarbons	Poor
Shore A Hardness	50
Contains Lubricant	Yes

Product Compliance

[For compliance documentation, visit the product page on TE.com>](#)

EU RoHS Directive 2011/65/EU	Compliant
------------------------------	-----------



EU ELV Directive 2000/53/EC	Compliant
China RoHS 2 Directive MIIT Order No 32, 2016	No Restricted Materials Above Threshold
EU REACH Regulation (EC) No. 1907/2006	Current ECHA Candidate List: JAN 2025 (247) Candidate List Declared Against: JAN 2025 (247) Does not contain REACH SVHC
Halogen Content	Low Halogen - Br, Cl, F, I < 900 ppm per homogenous material. Also BFR/CFR/PVC Free
Solder Process Capability	Not applicable for solder process capability

Product Compliance Disclaimer

This information is provided based on reasonable inquiry of our suppliers and represents our current actual knowledge based on the information they provided. This information is subject to change. The part numbers that TE has identified as EU RoHS compliant have a maximum concentration of 0.1% by weight in homogenous materials for lead, hexavalent chromium, mercury, PBB, PBDE, DBP, BBP, DEHP, DIBP, and 0.01% for cadmium, or qualify for an exemption to these limits as defined in the Annexes of Directive 2011/65/EU (RoHS2). Finished electrical and electronic equipment products will be CE marked as required by Directive 2011/65/EU. Components may not be CE marked. Additionally, the part numbers that TE has identified as EU ELV compliant have a maximum concentration of 0.1% by weight in homogenous materials for lead, hexavalent chromium, and mercury, and 0.01% for cadmium, or qualify for an exemption to these limits as defined in the Annexes of Directive 2000/53/EC (ELV). Regarding the REACH Regulation, the information TE provides on SVHC in articles for this part number is based on the latest European Chemicals Agency (ECHA) 'Guidance on requirements for substances in articles' posted at this URL: <https://echa.europa.eu/guidance-documents/guidance-on-reach>

Compatible Parts

TE Part # 2299116-1
MARELLI AMT CFC400X AG.A000823

TE Part # CAT-T4827-CH8172
Timer Connector Housing

TE Part # 2-2141894-1
JPT A REC 2.8 Contact SWS Au

TE Part # 2-966694-1
FLA-STE-GH2,8RD2X5P

TE Part # CAT-N10-RC4828
2.8mm Connectors for 48 Volt Ready Connectivity Solutions

TE Part # CAT-AM705-T273
AMP MCP, RECEPTACLE AND TAB

TE Part # 2209520-6
46POS. REC HOUSING ASSY

TE Part # 2349074-1
4POS,AMP MCP 2.8K,REC HSG ASSY



TE Part # 2-2141892-1
JPT A REC 2.8 Contact SRC Au



TE Part # CAT-AM705-CH8172
AMP MCP, SEALED CONNECTOR HOUSING



TE Part # 1-284844-0
12 POS MCP HYBRID MALE CONNECTOR



TE Part # 3-2109313-2
060/110 HYB 8P SLD PLUG ASSY D



TE Part # 2209545-1
94P,MQS CB,REC HSG,ASSY,SEALED



TE Part # 6-964300-6
TAB A 2.8x0.8 CONTACT SWS



TE Part # CAT-T4827-T273
TIMER, RECEPTACLE AND TAB



TE Part # 2299450-1
14P TAB HOUSING ASSY



TE Part # 4-964300-1
TAB A 2.8x0.8 CONTACT SWS



TE Part # 2219498-2
CAVITY PLUG FOR MCON1.2



TE Part # CAT-NB3-MRC48
Mixed (Signal and Power) 48V Ready Connectors



TE Part # 1703661-1
6POS, MIXED,REC HSG,ASSY

Also in the Series | **Timer Connector System**



Automotive Connector Locks & Position Assurance(15)

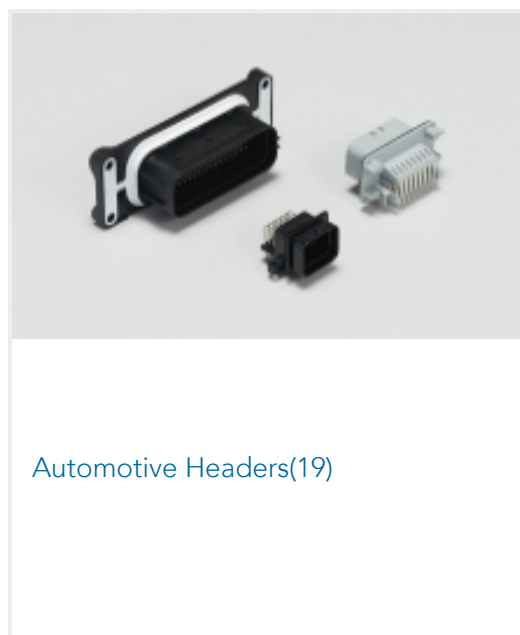

Automotive Headers(19)

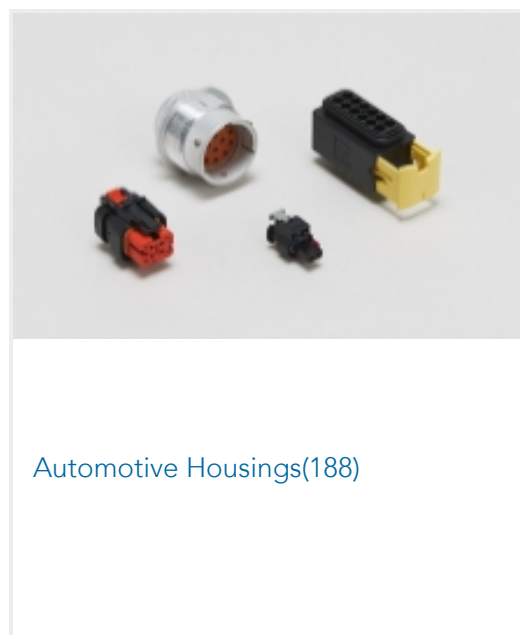

Automotive Housings(188)

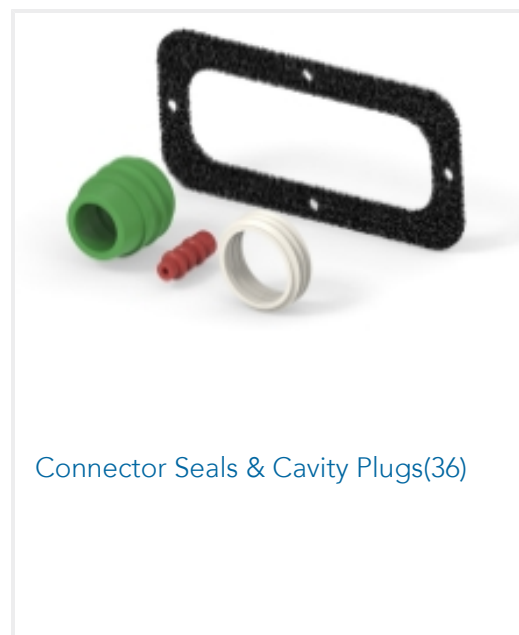

Connector Seals & Cavity Plugs(36)

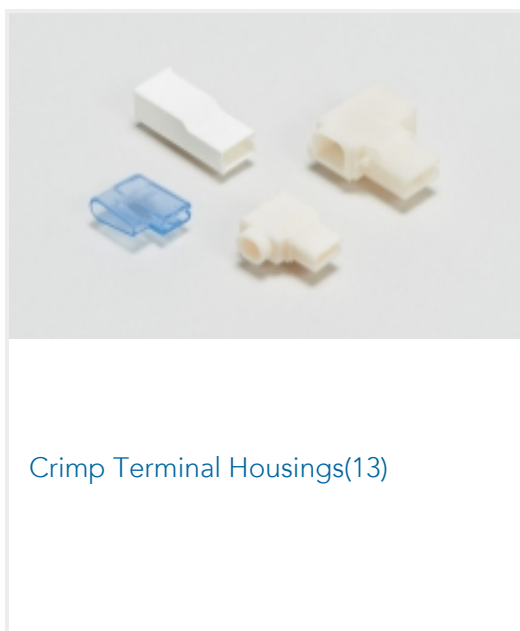

Crimp Terminal Housings(13)

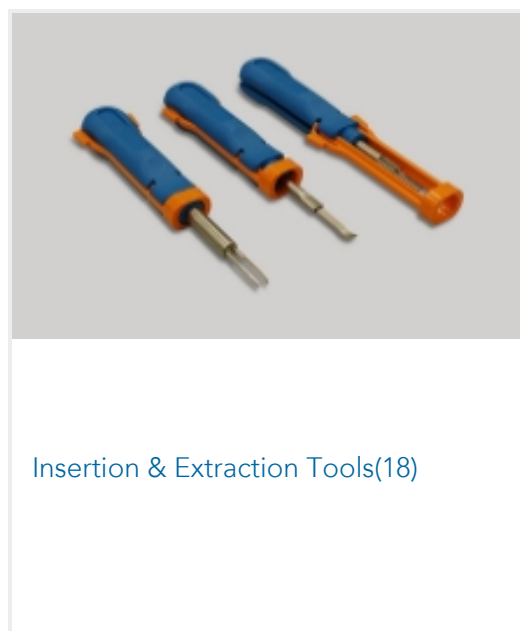

Insertion & Extraction Tools(18)

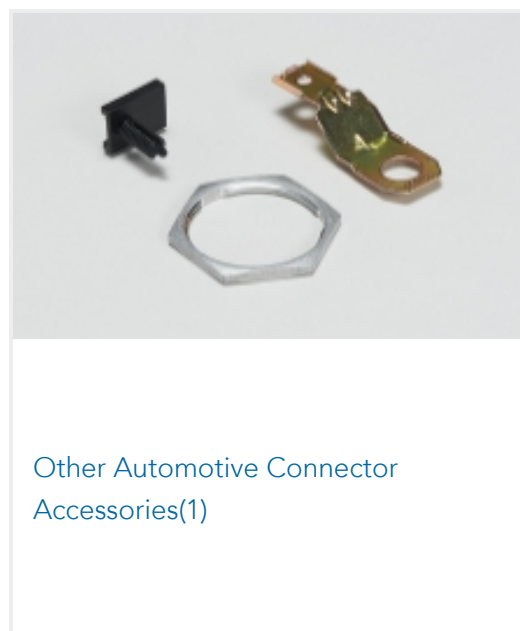

Other Automotive Connector Accessories(1)



PCB Headers & Receptacles(19)

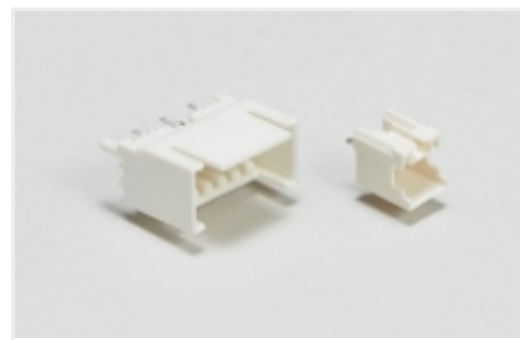

Rectangular Power Connectors(2)

Wire-to-Board Headers & Receptacles
(19)

Customers Also Bought

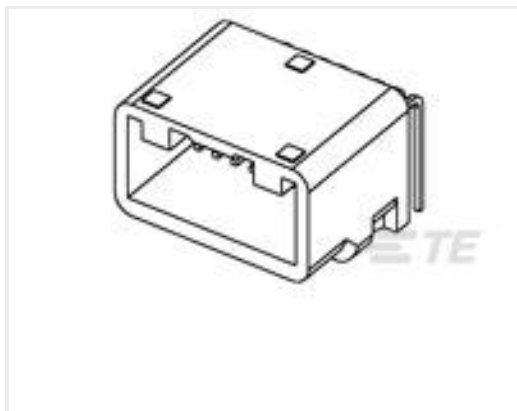
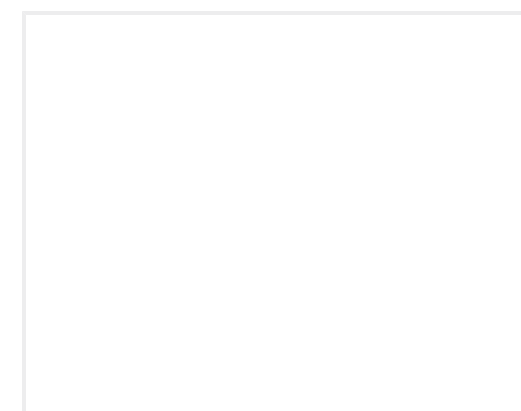
TE Part #1-1318382-4
025 16POS CAP ASSY H RNDTE Part #CAT-T4827-T273
TIMER, RECEPTACLE AND TABTE Part #1745011-1
PANEL HOOKTE Part #1379675-5
12W TAB HSG ASSY NATURALTE Part #284863-1
SINGLE WIRE SEAL F.EXT.INS.DIATE Part #1563126-1
2. LOCK,10 POS MALE HOUSINGTE Part #CAT-SI261-P729A
Glow Wire Signal Double Lock PlugTE Part #EFMX-X-X00136
FMC JAE MIN 4b F_NE5-4-L2M

Documents

Product Drawings

SINGLE WIRE SEAL INSULATION DI

English

CAD Files

Customer View Model

[ENG_CVM_CVM_963294-1_E.2d_dxf.zip](#)

English

3D PDF

3D

Customer View Model

[ENG_CVM_CVM_963294-1_E.3d_igs.zip](#)

English

Customer View Model

[ENG_CVM_CVM_963294-1_E.3d_stp.zip](#)

English

By downloading the CAD file I accept and agree to the [Terms and Conditions](#) of use.



Product Specifications

CAVITY PLUG (HYB 38P ISL PLUG)

English

Product Specification

Japanese

Product Specification

English

MQS CLEAN BODY PLUG ASSY 81P & 40P

Japanese

Product Specification

Japanese

Product Specification

English

Instruction Sheets

Instruction Sheet (non U.S.)

English

Instruction Sheet (non U.S.)

Japanese